

PAGE 3

DTC-EXL

DATA PRINT-OUT DIGITAL TORQUE WRENCHES



PAGE 4

DTDK-EXL

DIGITAL TORQUE DRIVER WITH CONNECTED DISPLAY



PAGE 4

DTC-N5EXL

DIGITAL TORQUE WRENCH WITH CONNECTED DISPLAY

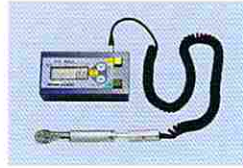

PAGE 5

SPK

PRE-SET TORQUE WRENCHES



PAGE 6

RSPK

PRE-SET, RING TORQUE WRENCHES



PAGE 7

QLK

ADJUSTABLE, RATCHET TORQUE WRENCHES



PAGE 8

QSPK

PRE-SET, RATCHET TORQUE WRENCHES



PAGE 9

SPCK

PRE-SET, REPLACEABLE HEAD TORQUE WRENCHES



PAGE 10

LCK

ADJUSTABLE, REPLACEABLE HEAD TORQUE WRENCHES



PAGE 11

HYK

ADJUSTABLE WRENCH HEADS, ADJUSTABLE TORQUE WRENCHES



PAGE 12

HEADS

OPTIONAL REPLACEABLE HEADS



PAGE 13

QLK-LR

LARGE HUB NUT TORQUE WRENCHES



PAGE 14

FK

INDICATOR PLATE TORQUE WRENCHES



PAGE 15

TMK

DIAL INDICATOR TORQUE WRENCHES

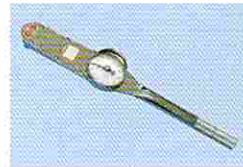

PAGE 16

TOK

DIAL INDICATOR TORQUE WRENCHES



PAGE 17

LTDK

CLUTCH RELEASE TORQUE SCREW DRIVERS



PAGE 18

STDK

PRE-SET TORQUE DRIVERS



PAGE 19

DPSK

DIAL GAUGE TORQUE DRIVERS



PAGE 20

SGK

TORQUE GAUGES



PAGE 21

KDTA-SV

DIGITAL TORQUE ANALYZERS



PAGE 22

KDTA-SVH

LARGE DIGITAL TORQUE ANALYZERS



PAGE 22

TPK-3

STANDARD PRINTER



PAGE 23

KDTA-SVII

DIGITAL TORQUE ANALYZERS



PAGE 23

KDTA-SVEX

AUTOMATIC DIGITAL TORQUE ANALYZERS



PAGE 24

KDTA-DH

DIGITAL TORQUE ANALYZERS FOR TORQUE DRIVERS



PAGE 24

KDTA-D

DIGITAL TORQUE ANALYZERS FOR ELECTRIC DRIVERS



PAGE 25

CTK-XL CAP TESTER

DIGITAL CAP TORQUE ANALYZERS



PAGE 26

TK

TENSION GAUGES



PAGE 27

TCSK-99MA

MULTI-FUNCTION TORQUE TASK MANAGER / ANALYZER



PAGE 28

SWP Series

TORQUE TOOLS FOR TCSK

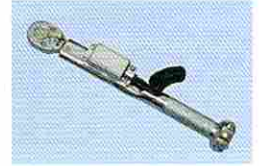

DTC-EXL DATA PRINT-OUT DIGITAL TORQUE WRENCHES

Newly designed, features a multi-function digital read-out.



FEATURES

- Accuracy : $\pm 1\%$ of indicated value +1 increment, over the full range
- Display : torque reading 4-digit LCD display
- Measurement modes : ①Peak hold ②Peak to peak-hold ③Run
- Direction of measurement : Automatic CW/CCW changeover, provided with CW/CCW status display
- Power supply : two rechargeable "AA" 1.2V batteries and a 100-240V battery charger
- Battery life : Approximately 20 hours with fully charged batteries (continuous operation)
- Power off : Auto power-off, approximately 3 minutes 40 seconds
- Tolerance setting : Automatic judgement capability per the Min/Max settings
- Data memory : 100 pieces of data
- Output : Printer output (exclusively to a TPK-3), analog output $\ll 0$ to 1.024 (mid point) to 2.048 V \gg

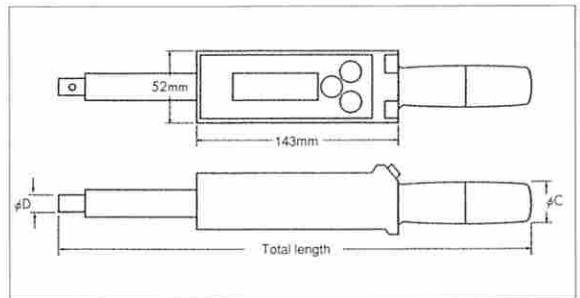

Model	Range (CW/CCW)	Increment	Total length (mm)	φ D (mm)	φ C (mm)	Weight (kg)	Accessory
DTC-100EXL	10~100 kgf·cm	0.1 kgf·cm	300	10	26	0.7	120 QCK
DTC-500EXL	50~500 kgf·cm	0.5 kgf·cm	324	12	26	0.7	450 QCK
DTC-1000EXL	100~1000 kgf·cm	1 kgf·cm	365	15	32	0.8	900 QCK
DTC-2000EXL	200~2000 kgf·cm	1 kgf·cm	380	18	32	0.9	1800 QCK
DTC-3000EXL	3~30 kgf·m	0.02 kgf·m	535	22	32	1.5	2800 QCK
DTC-5000EXL	5~50 kgf·m	0.05 kgf·m	1,063	30	34	3.9	7000 QCK
DTC-10000EXL	10~100 kgf·m	0.1 kgf·m	1,417	34	34	7.3	10000 QCK
DTC-N10EXL	1~10 N·m	0.01 N·m	300	10	26	0.7	120 QCK
DTC-N50EXL	5~50 N·m	0.05 N·m	324	12	26	0.7	450 QCK
DTC-N100EXL	10~100 N·m	0.1 N·m	365	15	32	0.8	900 QCK
DTC-N200EXL	20~200 N·m	0.1 N·m	380	18	32	0.9	1800 QCK
DTC-N300EXL	30~300 N·m	0.2 N·m	535	22	32	1.5	2800 QCK
DTC-N500EXL	50~500 N·m	0.5 N·m	1,063	30	34	3.9	7000 QCK
DTC-N1000EXL	100~1000 N·m	1 N·m	1,417	34	34	7.3	10000 QCK
DTC-P180EXL	8~80 lbf·in	0.01 lbf·in	300	10	26	0.7	120 QCK
DTC-P1400EXL	40~400 lbf·in	0.1 lbf·in	324	12	26	0.7	450 QCK
DTC-P1800EXL	80~800 lbf·in	0.1 lbf·in	365	15	32	0.8	900 QCK
DTC-PF100EXL	10~100 lbf·ft	0.1 lbf·ft	380	18	32	0.9	1800 QCK
DTC-PF200EXL	20~200 lbf·ft	0.1 lbf·ft	535	22	32	1.5	2800 QCK
DTC-PF400EXL	40~400 lbf·ft	0.2 lbf·ft	1,063	30	34	3.9	7000 QCK
DTC-PF800EXL	80~800 lbf·ft	1 lbf·ft	1,417	34	34	7.3	10000 QCK

DTDK-EXL

DIGITAL TORQUE DRIVER WITH CONNECTED DISPLAY

The display is separate from the driver. Complete tightening control for small screws.

FEATURES

- Accuracy : $\pm 1\%$ of indicated value +1 increment, over the full range
- Display : torque reading 4-digit LCD display
- Measurement modes : ①Peak hold ②Peak to peak-hold ③Run
- Direction of measurement : Automatic CW/CCW changeover, provided with CW/CCW status display
- Power supply : two rechargeable "AA" 1.2V batteries and a 100-240V battery charger
- Battery life : Approximately 20 hours with fully charged batteries (continuous operation)
- Power off : Auto Power-off, approximately 3 minutes 40 seconds
- Tolerance setting : Automatic judgement capability per the Min/Max settings
- Data memory : 100 pieces of data
- Output : Printer output (exclusively to a TPK-3), analog output << 0 to 1.024 (mid point) to 2.048 V >>

Model	Range (CW/CCW)	Increment	Weight (kg)
DTDK-20EXL	2~20 kgf·cm	0.01 kgf·cm	0.6
DTDK-50EXL	5~50 kgf·cm	0.05 kgf·cm	0.6
DTDK-N2EXL	20~200 cN·m	0.1 cN·m	0.6
DTDK-N5EXL	50~500 cN·m	0.5 cN·m	0.6
DTDK-PI40EXL	4~40 lbf.in	0.01 lbf.in	0.6

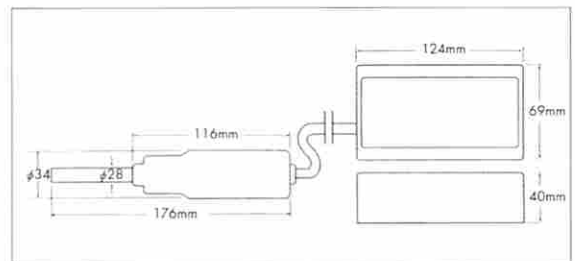

DTC-N5EXL

DIGITAL TORQUE WRENCH WITH CONNECTED DISPLAY

The display is separate from the wrench. The slender wrench body facilitates measuring lower torques.

FEATURES

- Accuracy : $\pm 1\%$ of indicated value +1 increment, over the full range
- Display : torque reading 4-digit LCD display
- Measurement modes : ①Peak hold ②Peak to peak-hold ③Run
- Direction of measurement : Automatic CW/CCW changeover, provided with CW/CCW status display
- Power supply : two rechargeable "AA" 1.2V batteries and a 100-240V battery charger
- Battery life : Approximately 20 hours with fully charged batteries (continuous operation)
- Power off : Auto Power-off, approximately 3 minutes 40 seconds
- Tolerance setting : Automatic judgement capability per the Min/Max settings
- Data memory : 100 pieces of data
- Output : Printer output (exclusively to a TPK-3), analog output << 0 to 1.024 (mid point) to 2.048 V >>

Model	Range (CW/CCW)	Increment	Weight (kg)
DTC-50EXL	5~50 kgf·cm	0.05 kgf·cm	0.5
DTC-N5EXL	50~500 cN·m	0.5 cN·m	0.5
DTC-PI40EXL	4~40 lbf.in	0.01 lbf.in	0.5

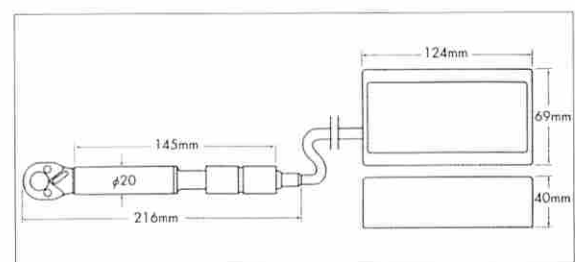

SPK PRE-SET TORQUE WRENCHES

Audible and tangible "CLICK" when the set torque is reached, assuring a securely tightened joint. This series is well-suited for production line use.

FEATURES

- A single function wrench, used for a single setting combination of fastener size and torque setting.
- Most suited for tightening multiple same-size fasteners at the same torque in a production line.
- Setting confirmation unnecessary.
- Can be used effectively in confined spaces.
- Tightening to set torque only in the direction of the arrow indicator, but can be used for general tightening in the other direction as well.
- Accuracy : ±3% of pre-set value

USING AN SPK WRENCH

With the wrench head completely engaging the fastener, and your grip centered on the groove in the wrench handle, pull the wrench in the direction indicated by the arrow on the wrench. When the pre-set torque is reached, there will be an audible and tangible "click" and for a split second the wrench will suddenly require less force to pull. Continuing to pull the wrench further will add torque over the setting.

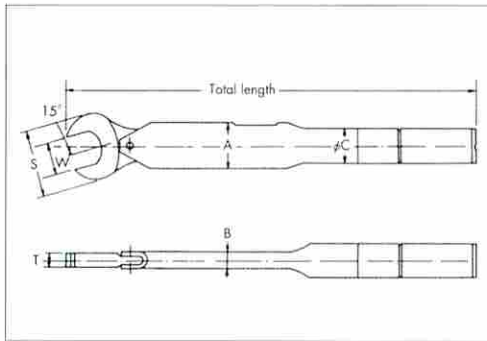

EXAMPLE OF ORDER

Model Size(W) Pre-set Value
 | | |
 N190SPK 10 × 14N·m

SPK Model	Range kgf·cm	N-SPK Model	Range N·m	Available sizes (W) mm					Total length mm	Dimensions (mm)					Weight kg
										Head		Body			
				S	T	A	B	C							
30SPK	5~30	N30SPK	0.5~3	5.5	6				152	24	5	19.5	7.5	15	0.1
				7	8	9	10								
80SPK	15~80	N80SPK	1.5~8	5.5	6	7			175	24	5	19.5	7.5	15	0.11
				8	9	10	11	12							
190SPK	35~190	N190SPK	3.5~19	10	11				203	27	7	19.5	7.5	15	0.15
				12	13	14			205	30					
				17	19				213	35					
380SPK	80~380	N380SPK	8~38	10	11	12	13	14	248	35	8	26.6	8.2	20	0.29
				17	19				252	39					
				21	22	23	24		256	45					
				26	27	29	30	32	264	52					
670SPK	130~670	N670SPK	13~67	14	17	19	21		319	45	10	25.8	9.7	20	0.45
				22	24	26			325	50	0.46				
				27	30	32			330	56	0.47				
				36	41				342	65	0.49				
1200SPK	240~1,200	N1200SPK	24~120	17	19	22			390	52	11	32.8	11.3	25	0.75
				24	26	27			397	57					0.77
				29	30	32			403	62					0.79
				36	41				410	71					0.81
				19					436	53					13
1600SPK	300~1,600	N1600SPK	30~160	22	24	26			440	56	14	32.8	11.3	25	0.97
				27	30	32			449	64					0.99
				36	41				457	73					1.1
				19	22				573	60					1.1
2200SPK	450~2,200	N2200SPK	45~220	24	27				579	65	15	35.6	12.5	27.2	1.2
				30	32	36			585	72					1.4
				41					597	82					1.5
				22	24				650	67					1.3
3100SPK	650~3,100	N3100SPK	65~310	27	30	32			654	72	16	38.0	16	30	1.32
				36	41				662	82					1.4
				24	27				833	74					1.45
4200SPK	900~4,200	N4200SPK	90~420	30	32				838	78	18	43.3	17.8	34	1.46
				36					843	82					1.47
				41					847	88					1.5
				46					860	94					1.52

RSPK PRE-SET, RING TORQUE WRENCHES

Can be used for accurate torque application even on joints inaccessible with other wrenches.

FEATURES

- Suited for joints not accessible with other wrenches
- A single function wrench, used for a single setting combination of fastener size and torque setting.
- Most suited for tightening multiple same-size fasteners at the same torque on a production line.
- Setting confirmation unnecessary.
- Accuracy : $\pm 3\%$ of pre-set value

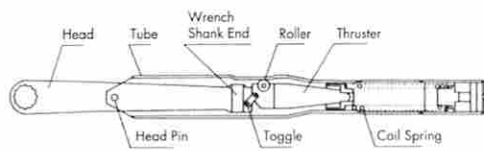

USING AN RSPK WRENCH

The ring head of RSPK wrenches is offset at a 45° angle making certain joints particularly accessible. With the wrench head completely engaging the fastener, pull the wrench handle in the direction indicated by the arrow on the wrench. When the pre-set torque is reached, there will be an audible and tangible "click" and for a split second the wrench will suddenly require less force to pull. Continuing to pull the wrench further will add torque over the setting. The inner mechanism is automatically reset when the wrench is disengaged from the fastener to go on to the next job.



Model	Available sizes (W) mm	Dimensions Head		Model	Available sizes (W) mm	Dimensions Head		Model	Available sizes (W) mm	Dimensions Head	
		S	T			S	T			S	T
30RSPK N30RSPK	5.5	4		80RSPK N80RSPK	5.5	4		190RSPK N190RSPK	10	16	7
	6	10	5		6	10	5		11	18	7
	7				7				12	19	8
	8	13	6		8	13	6		13	20	8.5
	9	14			9	14			14	22	9
	10	16	7		10	16	7		17	26	10
					11	18			19	29	10.5
					12	19	8		22	33	12

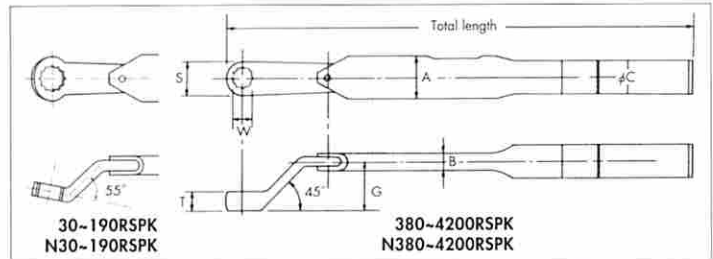

RSPK Model	Range kgf·cm	N-RSPK Model	Range N·m	Available sizes (W) mm				Total length mm	Dimensions (mm)					Weight kg	
				Head					Body						
				S	T	G	A	B	C						
30RSPK	5~35	N30RSPK	0.5~3.5	5.5	6			175	★1		19.5	7.5	15	0.12	
80RSPK	20~90	N80RSPK	2~9	5.5	6	7		197	★2		19.5	7.5	15	0.13	
				8	9	10									
190RSPK	40~210	N190RSPK	4~21	10				222	★3		19.5	7.5	15	0.21	
				11	12	13	14	225						0.21	
				17	19	22		228						0.23	
380RSPK	90~420	N380RSPK	9~42	11	12	13	14	268	22	10	25	26.6	8.2	20	0.31
				17	19	22		273							0.39
670RSPK	140~730	N670RSPK	14~73	14	17			343	26	12	27	25.8	9.7	20	0.46
				19	22	24		348							0.48
				27	30	32		353							0.5
1200RSPK	250~1,270	N1200RSPK	25~127	19				413	32	13	29	32.8	11.3	25	0.8
				22	24			415							0.85
				27	30	32		428							0.9
				36				437							
1600RSPK	320~1,700	N1600RSPK	32~170	19	22	24		470	37	15	31	32.8	11.3	25	1.0
				27	30	32		474							1.2
				22	24	27		605							1.25
2200RSPK	480~2,300	N2200RSPK	48~230	22	24			608	41	16.5	33	35.6	12.5	27.2	1.3
				30	32			610							1.35
				36				612							1.4
				41				612							1.45
				22				682							1.35
3100RSPK	680~3,200	N3100RSPK	68~320	24	27	30		685	46	18	35	38	16	30	1.4
				32	36			688							1.45
				41				688							1.5
4200RSPK	950~4,300	N4200RSPK	95~430	27	30	32		880	52	37	43.3	17.8	34	1.55	
				36				885						1.6	
				41				890						1.65	
				46				895						1.7	

QLK ADJUSTABLE, RATCHET TORQUE WRENCHES

Freely set torque values within the capacity range. Replaceable socket, ratchet wrenches.

FEATURES

- The ratchet improves efficiency. These wrenches are well suited for repetitive work.
- By replacing the sockets, various sizes of fasteners can be tightened within the tool's capacity range.
- By reversing the ratchet, the wrench can be used to loosen fasteners counter-clockwise.
- Tightening to a torque setting can only be done clockwise.
- Accuracy : $\pm 3\%$ of indicated value over the full range.

ADJUSTING THE TORQUE SETTING

◆ 30QLK~5600QLK

- (1) Loosen the lock screw. (See Fig. 1)
- (2) Turn the sub-scale and adjust to a torque value (the main scale plus the sub-scale)(See Fig.2)
- (3) Tighten the lock screw. (If the lock screw hits the pin before completely tightening, then change the position of the pin)

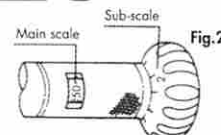
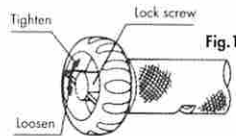

Set torque value: $50+2=52\text{kgf}\cdot\text{m}$

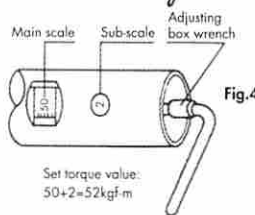

Set torque value: $50+2=52\text{kgf}\cdot\text{m}$

◆ 7000QLK~14000QLK

- (1) When applicable, mount the extension bar snugly all the way onto the body of the wrench.
- (2) With the extension bar mounted (See Fig.3), insert the hexagonal side of the adjusting box wrench.
- Without the extension bar (See Fig.4), insert the hexagonal side of the adjusting box wrench into the body.
- (3) Turn the adjusting box wrench to set the torque value. (the main scale plus the sub-scale)

★ Torque adjusting box wrench



Size(mm)

(N)7000QLK~10000QLK	8
(N)14000QLK~21000QLK	10

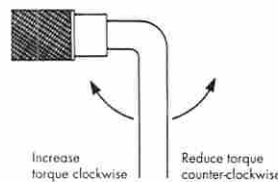

30~5600QLK

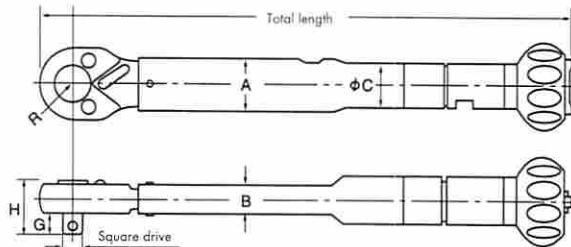

7000~21000QLK

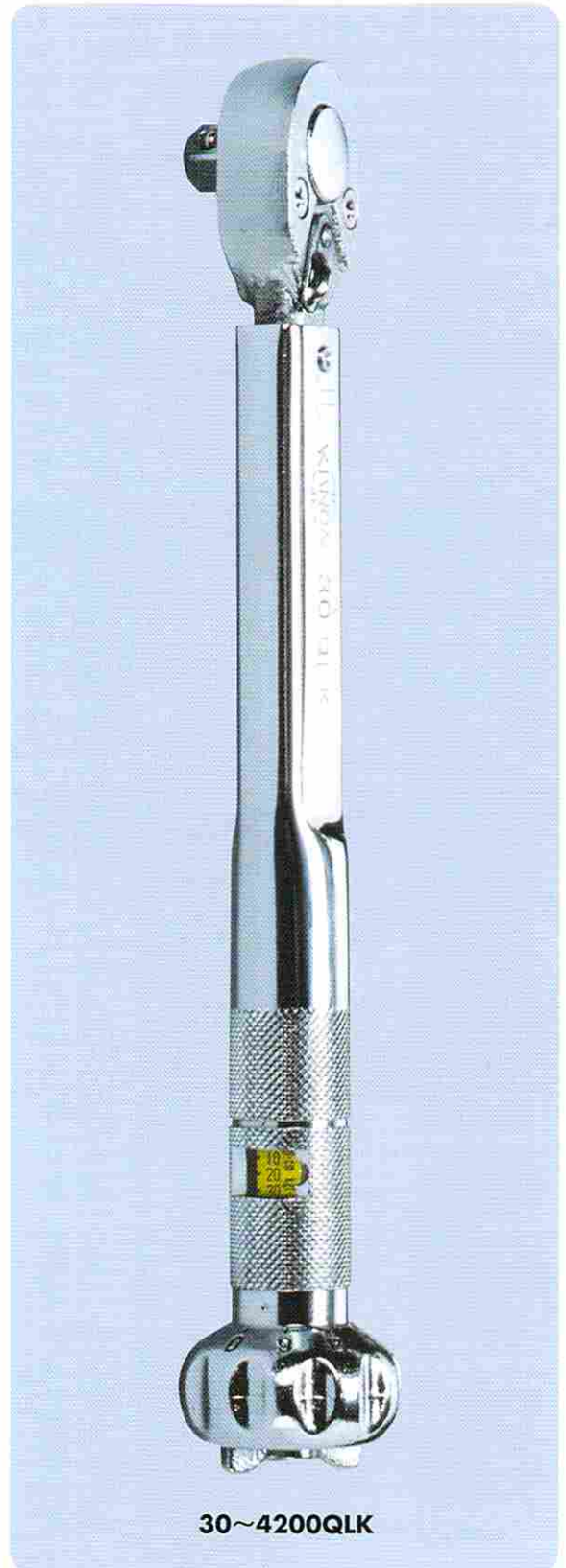
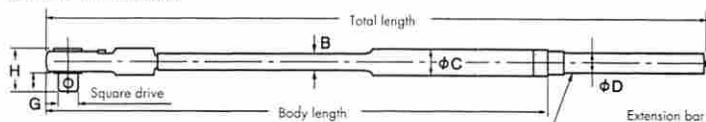

30~4200QLK

Model QLK	Range kgf-cm/kgf-m	Increment kgf-cm/kgf-m	Model N-QLK	Range cN-m/N-m	Increment cN-m/N-m	Model PI-QLK	Range lbf-in	Increment lbf-in	Square drive mm	Total length mm	Dimensions (mm)								Weight kg	Standard Accessory	
											Head				Body						Body length
											H	G	R	A	B	C	D				
30QLK	10-30	0.5	N30QLK	100-300	5				6.35 (1/4")	186	18.8	7.5	12							0.18	
60QLK	20-60	1	N60QLK	2-6	0.1																
120QLK	40-120	2	N120QLK	4-12	0.2	PI 120QLK	40-120	2		231.5			15.5	18.2	9.6	15			0.27		
230QLK	70-230	2	N230QLK	7-23	0.2	PI 230QLK	70-230	2		240									0.29		
250QLK	50-250	2	N250QLK	5-25	0.2				9.53 (3/8")	253.5		25	11	16	25	11.4	20		0.45		
450QLK	100-450	5	N450QLK	10-45	0.5	PI 450QLK	100-450	5													
500QLK	100-500	5	N500QLK	10-50	0.5																
900QLK	200-900	10	N900QLK	20-90	1																
1000QLK	200-1000	10	N1000QLK	20-100	1	PI 1000QLK	200-1000	10		352		31		19.5	27.5	12.4	21.7		0.69		
1400QLK	400-1400	10	N1400QLK	40-140	1				12.7 (1/2")	392			14								
1800QLK	400-1800	20	N1800QLK	40-180	2					478		33		23	34	15.4	27.2		1.45		
2000QLK	400-2000	20	N2000QLK	40-200	2	PI 2000QLK	400-2000	20													
2800QLK	4-28	0.2	N2800QLK	40-280	2					678	42			23.5	35				1.9		
4200QLK	6-42	0.2	N4200QLK	60-420	2				19.05 (3/4")	950	42.7		20	27	38	16	30		3.3		
5600QLK	8-56	0.3	N5600QLK	80-560	3					1,195	49.5			34	43.5	18	34		5		
7000QLK	10-70	0.5	N7000QLK	100-700	5					1,314				46	19.2	35.4	27.2	990	6.2		
8500QLK	10-85	0.5	N8500QLK	100-850	5					1,388									8.5		
10000QLK	10-100	0.5	N10000QLK	100-1000	5					1,538									9.8		
14000QLK	20-140	1	N14000QLK	200-1400	10				25.4 (1")	1,844			27	38	54	23	42.7	31.8	1,105	8.5	Torque adjusting box wrench
15000QLK	20-150	1	N15000QLK	200-1500	10									44	66	26	51	40	1,144	14	
21000QLK	70-210	1	N21000QLK	700-2100	10					2,064								34	1,704	19.5	

QSPK

PRE-SET, RATCHET TORQUE WRENCHES

Pre-set torque value. Improved work efficiency with ratchet square drive.

FEATURES

- The ratchet drive enables quickly tightening fasteners to the preset torque. Suitable for repetitive jobs.
- The wrench's inner mechanism automatically resets itself for the next job after disengaging from a tightened joint.
- Accuracy : ±3% of set value.

EXAMPLE OF ORDER

Model Pre-set Value
| |
N900QSPK × 72N·m

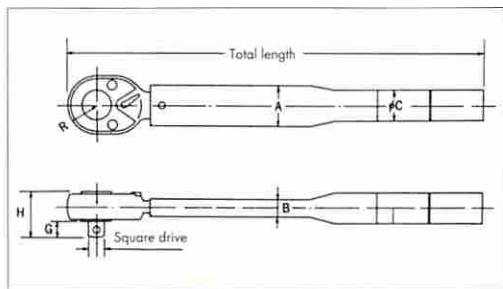

RE-SETTING THE PRE-SET TORQUE

(SPK · RSPK · QSPK · SPCK · TYPES)

- (1) Remove the screw cap with a slot drive screw driver.
- (2) Loosen the setting screw with a hex wrench.
- (3) Using the special adjusting tool or equivalent, rotate the slotted plate clockwise to increase torque or counterclockwise to reduce torque. Check the setting with a torque analyzer.

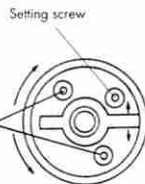
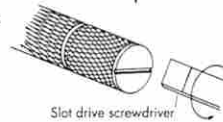

★ Adjusting tools



- (4) Tighten the setting screw with a hex wrench.
- (5) Screw on the screws cap and tighten it.

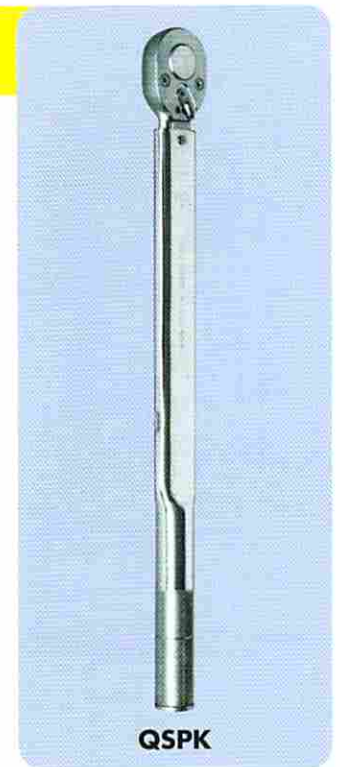

Model	Applicable Torque wrench
Adjusting Tool No.1	(N)30,80,190SPK, (N)30,80,190RSPK, (N)60,120,230,250QSPK
Adjusting Tool No.2	(N)380,670SPK, (N)380,670RSPK, (N)450,500,900,1000,1400QSPK
Adjusting Tool No.3	(N)1200,1600,2200SPK, (N)1200,1600,2200RSPK, (N)1800,2000QSPK
Adjusting Tool No.4	(N)3100SPK, (N)3100RSPK, (N)2800QSPK
Adjusting Tool No.5	(N)4200SPK, (N)4200RSPK, (N)4200QSPK

* Adjusting tool is option.

Model QSPK	Range kgf-cm	Model N-QSPK	Range N-m	Model PI-PF-QSPK	Range lbf-in/lbf-ft	Square drive mm	Total length mm	Dimensions (mm)								Weight kg
								Head				Body				
								H	G	R	A	B	C			
60QSPK	20-60	N 60QSPK	2-6	PI 60QSPK	20-60 lbf-in	6.35 (1/4")	174	19.5	7.5	12.5				0.17		
120QSPK	40-120	N 120QSPK	4-12	PI 120QSPK	40-120 -						18.2	9.6	15			
230QSPK	70-230	N 230QSPK	7-23	PI 230QSPK	70-230 -		220							0.25		
250QSPK	70-250	N 250QSPK	7-25			9.53 (3/8")				16						
450QSPK	100-450	N 450QSPK	10-45	PI 450QSPK	100-450 -		240				25	11.4	20	0.38		
500QSPK	100-500	N 500QSPK	10-50													
900QSPK	200-900	N 900QSPK	20-90	PI 900QSPK	200-900 -		340							0.64		
1000QSPK	200-1000	N 1000QSPK	20-100													
1400QSPK	400-1400	N 1400QSPK	40-140	PI 1400QSPK	400-1400 -	12.7 (1/2")	380		14					0.7		
1800QSPK	400-1800	N 1800QSPK	40-180	PI 1800QSPK	400-1800 -		463.5							1.35		
2000QSPK	400-2000	N 2000QSPK	40-200							23	34	15.4	27.2			
2800QSPK	600-2800	N 2800QSPK	60-280	PI 2800QSPK	600-2800 -		664	42						2.0		
4200QSPK	600-4200	N 4200QSPK	60-420	PF 4200QSPK	110-300 lbf-ft	19.05 (3/4")	980	49.5	20		34	43.5	18	34	4.3	

SPCK PRE-SET, REPLACEABLE HEAD TORQUE WRENCHES

Work at a set torque value can proceed smoothly while using various replaceable heads.

FEATURES

- Replaceable ratchet, open end wrench, ring, and hex drive heads are available.
- Pre-set torque wrench well suited for repetitive jobs at the specified torque value.
- Accuracy : $\pm 3\%$ of pre-set value

USING AN SPCK

- (1) Mount the head on the drive. (3) Pull the wrench in the direction indicated by the arrow.



- (2) Engage the fastener.

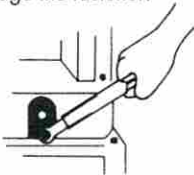

- (4) Stop tightening when the wrench "clicks" and is suddenly easier to pull

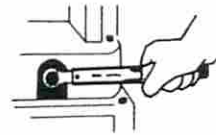

- (5) The job is done. Continuing to pull the wrench further will add torque over the setting.

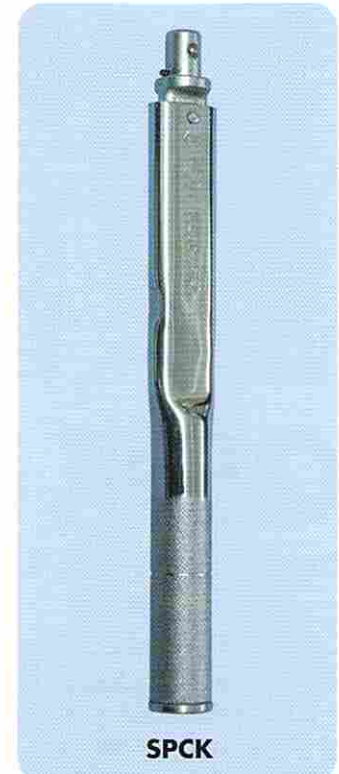

SPCK

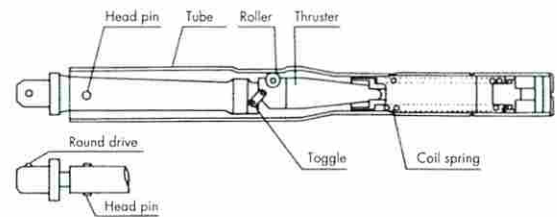
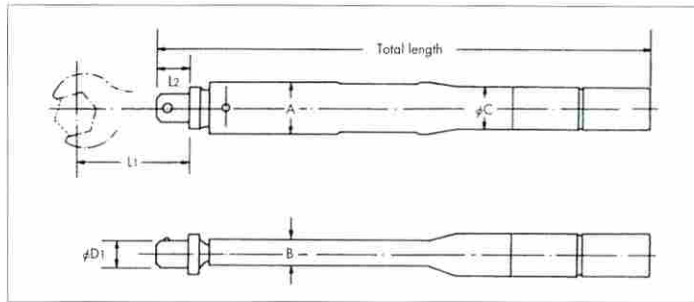

SPCK Model	Range kgf-cm	N-SPCK Model	Range N-m	Total length mm	Dimensions (mm)						Weight kg	Replaceable heads
					Head			Body				
					ϕD_1	L1	L2	A	B	ϕC		
60SPCK	20~60	N60SPCK	2~6	161	10	45	13	18.2	9.6	15	0.15	120QCK,230 { SCK, RCK HCK
120SPCK	40~120	N120SPCK	4~12									
230SPCK	70~230	N230SPCK	7~23	196	12	55	16	25	11.4	20	0.19	230 (QCK, SCK, RCK, HCK)
250SPCK	70~250	N250SPCK	7~25									
450SPCK	100~450	N450SPCK	10~45	220	15	65	18	27.5	12.4	21.7	0.27	450 (QCK, SCK, RCK, HCK)
500SPCK	100~500	N500SPCK	10~50									
900SPCK	200~900	N900SPCK	20~90	312	18	80	22	34	15.4	27.2	0.57	900 (QCK, SCK, RCK, HCK)
1000SPCK	200~1,000	N1000SPCK	20~100									
1800SPCK	400~1,800	N1800SPCK	40~180	428	22	100	27	38	16	30	0.92	1800 (QCK, SCK, RCK, HCK)
2000SPCK	400~2,000	N2000SPCK	40~200									
2800SPCK	600~2,800	N2800SPCK	60~280	590	27	100	27	39	16	30	1.7	2800 (QCK, SCK, RCK, HCK)
4400SPCK	600~4,400	N4400SPCK	60~440									
				893							2.6	4400 (QCK, SCK, RCK)

Optional Replaceable Heads (Refer to the page 12)



SCK (Open End head)



RCK (Ring head)

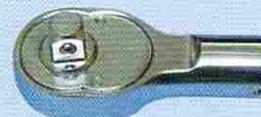

QCK (Ratchet head)



HCK (Hex drive head)

LCK

ADJUSTABLE, REPLACEABLE HEAD TORQUE WRENCHES

Freely replace heads according to work applications. The combination of replaceable heads and torque adjustability make this series extremely versatile.

FEATURES

- Ring, ratchet, open end wrench and hex drive heads are available.
- The torque can be set to any value within the capacity range.
- Models are available ranging from 20 kgf-cm to 14,000 kgf-cm.
- Accuracy : $\pm 3\%$ of indicated value over the full range

ADJUSTING THE TORQUE

60LCK~5600LCK

- (1) Loosen the lock screw. (See Fig.1)
- (2) Turn the sub-scale and adjust to a torque value.
(the main scale plus the subscale) (See Fig.2)
- (3) Tighten the lock screw. (If the lock screw hits the pin before completely tightening, then change the position of the pin)

7000LCK~14000LCK

- (1) When applicable, mount the extension bar snugly all the way onto the body of the wrench.
- (2) With the extension bar mounted (See Fig.3), insert the hexagonal end of the adjusting box wrench.
- Without the extension bar (See Fig.4), insert the hexagonal end of the adjusting box wrench into the body.
- (3) Turn the adjusting box wrench to set the torque value.
(Add the sub-scale to the main scale.)

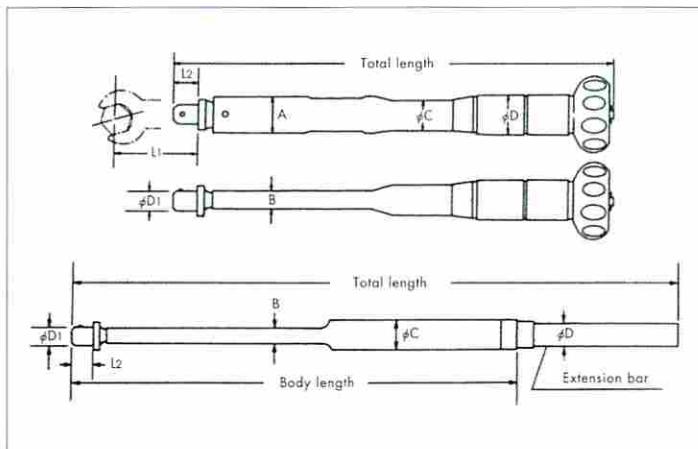
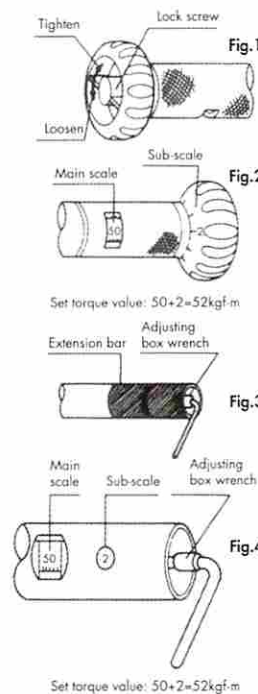

LCK

LCK Model	Range kgf-cm/kgf-m	Increment kgf-cm/kgf-m	N-LCK Model	Range N-m	Increment N-m	Total length mm	Dimensions (mm)							Body length	Weight kg	Replaceable heads	
							Head	Body			Body length						
							ϕD_1	L ₁	L ₂	A	B	C	D				
60LCK	20-60	1	N60LCK	2-6	0.1	173	10	45	13	18.2	9.6	15					120QCK, 230 { SCK, RCK, HCK
120LCK	40-120	2	N120LCK	4-12	0.2												0.17
230LCK	70-230	2	N230LCK	7-23	0.2	208											230 (QCK, SCK, RCK, HCK)
450LCK	100-450	5	N450LCK	10-45	0.5												0.2
900LCK	200-900	10	N900LCK	20-90	1	325	15	65	18	27.5	12.4	21.7					900 (QCK, SCK, RCK, HCK)
1800LCK	400-1,800	20	N1800LCK	40-180	2												0.36
2800LCK	4-28	0.2	N2800LCK	40-280	2	648	22	100	27	35	15.4	27.2					450 (QCK, SCK, RCK, HCK)
4400LCK	6-44	0.2	N4400LCK	60-440	2												0.59
5600LCK	8-56	0.3	N5600LCK	80-560	3	1086	30	125	45	43.5	18	34					1800 (QCK, SCK, RCK, HCK)
7000LCK	10-70	0.5	N7000LCK	100-700	5												1.3
8500LCK	10-85	0.5	N8500LCK	100-850	5	1267	34	130	47	54	23	42.7	31.8	876			2800 (QCK, SCK, RCK, HCK)
10000LCK	10-100	0.5	N10000LCK	100-1000	5												2.8
14000LCK	20-140	1	N14000LCK	200-1400	10	1700	38	160	60	66	26	51	40	1003			4400 (QCK, SCK, RCK)
																	4.9
																	7000 (QCK, SCK, RCK)
																	10000 (QCK, SCK, RCK)
																	14000 (QCK, SCK, RCK)

HVK ADJUSTABLE WRENCH HEADS, ADJUSTABLE TORQUE WRENCHES

Built-in "no play" worm screw

FEATURES

- Since the head can be taken off and reversed, the wrench can be used in confined spaces (in as small as a 30 degree turn) previously inaccessible to even other adjustable wrenches. (Tightening to a torque setting can only be done in the direction of the arrow.)
- There is hardly any play in the worm screw adjuster in the wrench head, which will improve your working efficiency. Without excess play, the torque wrench will not damage the corners of fasteners like ordinary wrenches will.
- Accuracy : $\pm 4\%$ of indicated value over the full range

USING AN HVK

■ Setting the opening

(1) Slide the jaws onto the fastener until it contacts the spring pin. (a)

(2) Tighten the adjusting worm screw so the jaws grip the fastener. (b)

(3) Loosen the adjusting worm screw just enough to allow removing the wrench from the fastener. (c)

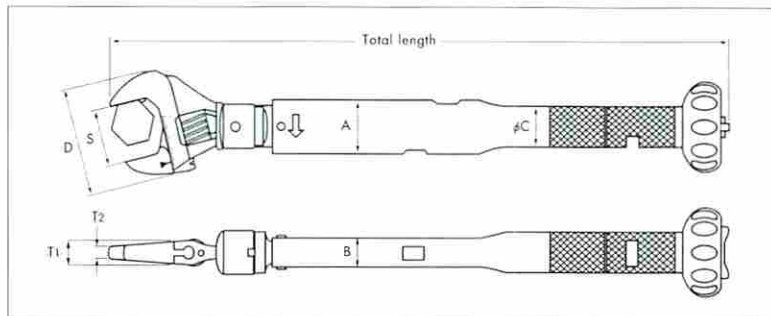
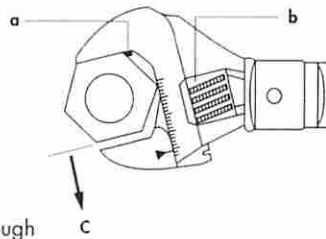

■ MCK

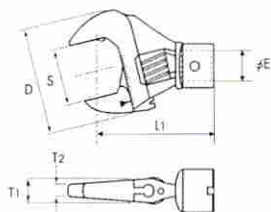

MCK Model	Opening Size (mm)	Dimensions (mm)				
	S	D	ϕE	L ₁	T ₁	T ₂
45MCK	10~25	48	12	57	10	5.5
90MCK	10~30	58	15	65	12	6
1800MCK	17~38	66	18	80	13	6.5

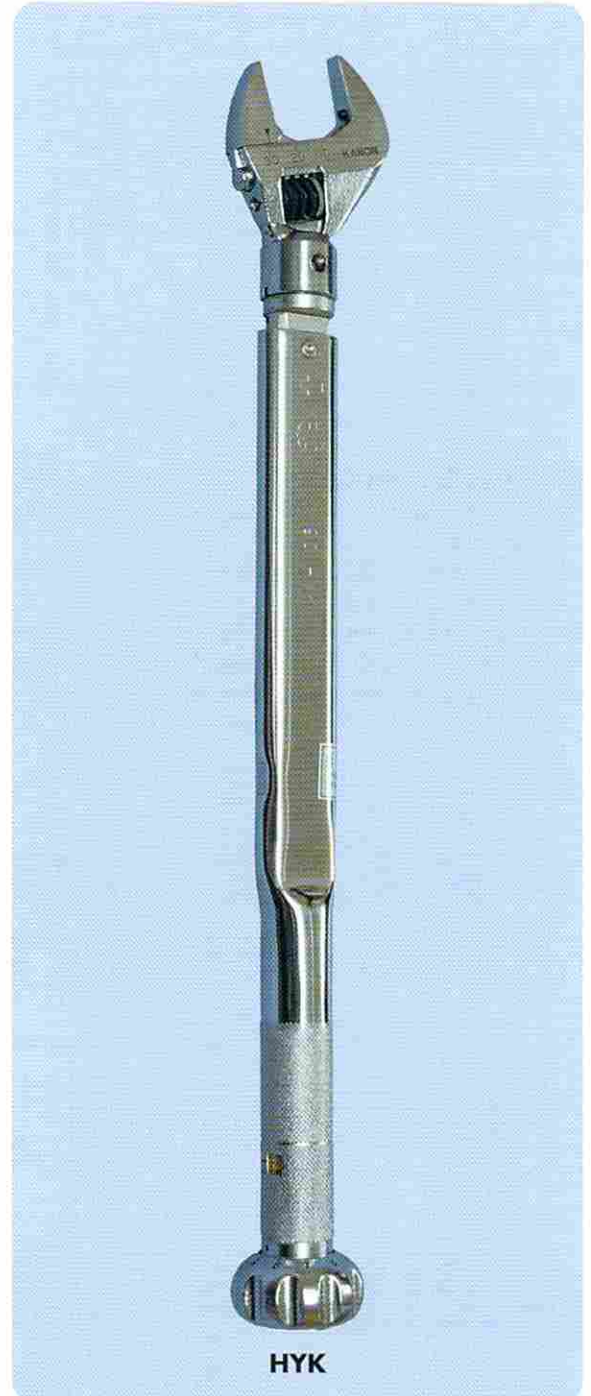

HVK

HVK Model	Range	Increment	N-HVK Model	Range	Increment	Total length	Opening Size (mm)	Dimensions (mm)						Weight
								Head			Body			
								D	T ₁	T ₂	A	B	ϕC	
450HVK	100~450	5	N45HVK	10~45	0.5	285	10~25	48	10	5.5	25	11.4	20	460
900HVK	200~900	10	N90HVK	20~90	1	386	10~30	58	12	6.0	27.5	12.4	21.7	740
1800HVK	400~1800	20	N180HVK	40~180	2	518	17~38	66	12.5	6.5	34	15.4	27.2	1,420

HEADS

OPTIONAL REPLACEABLE HEADS

SCK (Open End head)

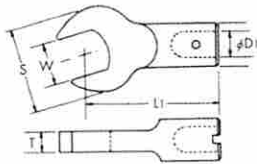

RCK (Ring head)

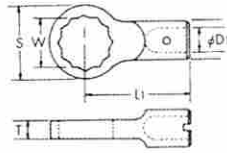

QCK (Ratchet head)

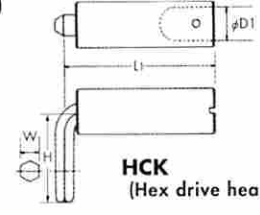
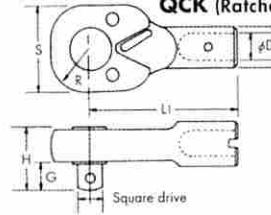

HCK (Hex drive head)

SCK open end heads

Unit : mm

SCK Model	Size (W)					S	T	L1	φD1	Applicable torque wrench	
	7	8	9	10	11						
230SCK	7	8	9	10	11	29	7	45	10	N160-230LCK N160-250SPCK N1250FCK DTC-50EXL DTC-100EXL	DTC-P140EXL DTC-P180EXL DTC-N5EXL DTC-N10EXL
	12	13	14	15	16	32					
	17	19	21	22		39					
	24					45					
450SCK	8	9	10	11		32	8	55	12	N1450LCK N1450-500SPCK N1500FCK DTC-500EXL	DTC-P1400EXL DTC-N50EXL
	12	13	14	15	16	36					
	17	19	21	22		44					
	24	27				50					
900SCK	12	13	14	15		40	10	65	15	N1900LCK N1900-1000SPCK N11000FCK DTC-1000EXL	DTC-P1800EXL DTC-N100EXL
	16	17	19	21	22	48					
	24	27	30			57					
1800SCK	17	19	21	22		56	14	80	18	N11800LCK N11800-2000SPCK N11500FCK DTC-2000EXL	DTC-P1100EXL DTC-N200EXL
	24	27	30			64					
	32	36	41			75					
2800SCK	19					59	16.5	100	22	N12800LCK N12800SPCK N12300FCK DTC-3000EXL	DTC-P1200EXL DTC-N300EXL
	21	22				61					
	24					63					
	27					67					
	30					69					
	32					71					
	36					75					
	41					80					
46					85						
4200SCK	27					71	25	125	25	N14200LCK N14200SPCK	
	30					74					
	32					76					
	36					79					
	41					84					
	46					90					
	50					94					
	55					97					
60					100						
4400SCK	19	22	24			70	100	22		N14400LCK N14400SPCK	
	27	30	32			78					
	36	41				84					
	46	50				94					
	55	60				100					
	60					104					
7000SCK	27					83	125	30		N15600-7000LCK DTC-5000EXL	DTC-P1400EXL DTC-N500EXL
	30					86					
	32					88					
	36					91					
	41					95					
	46					98					
10000SCK	46					102	130	34		N18500-10000LCK DTC-10000EXL	DTC-P1800EXL DTC-N1000EXL
	50					110					
	55					115					
	60					120					
	66					126					
	72					132					
14000SCK	41					110	160	38		N114000LCK	
	46					115					
	50					120					
	55					122					
	60					127					
	65					130					

RCK ring heads

Unit : mm

RCK Model	Size (W)					S	T	L1	φD1	Applicable torque wrench	
	7	8	9	10	11						
230RCK	7	8	9	10	11	18	8	45	10	N160-230LCK N160-250SPCK N1250FCK DTC-50EXL DTC-100EXL	DTC-P140EXL DTC-P180EXL DTC-N5EXL DTC-N10EXL
	12	13	14			21					
	17	19	22	24		31					
	8	10				19					
450RCK	11	12	13	14		10	55	12		N1450LCK N1450-500SPCK N1500FCK DTC-500EXL	DTC-P1400EXL DTC-N50EXL
	17	19	22			32					
	12	13	14			25					
900RCK	17	19	21	22		13	65	15		N1900LCK N1900-1000SPCK N11000FCK DTC-1000EXL	DTC-P1800EXL DTC-N100EXL
	24	27	30			42					
1800RCK	17	19	22			15	80	18		N11800LCK N11800-2000SPCK N11500FCK DTC-2000EXL	DTC-P1100EXL DTC-N200EXL
	24	27	30			45					
	32	36	41			58					
2800RCK	19	22	24			17	100	22		N12800LCK N12800SPCK N12300FCK DTC-3000EXL	DTC-P1200EXL DTC-N300EXL
	27	30	32			47					
	36	41				63					
4200RCK	27	30	32			20	125	25		N14200LCK N14200SPCK	
	36					57					
	41					58					
4400RCK	46	50				23	100	22		N14400LCK N14400SPCK	
	55	60				78					
	19	22	24			44					
	27	30	32			50					
	36	41				58					
	46	50				66					
7000RCK	27	30	32			20	125	30		N15600-7000LCK DTC-5000EXL	DTC-P1400EXL DTC-N500EXL
	36					62					
	41					65					
	46	50				70					
	55					80					
	60					80					
10000RCK	36					25	130	34		N18500-10000LCK DTC-10000EXL	DTC-P1800EXL DTC-N1000EXL
	41					28					
	46					30					
	50					33					
	55					37					
	60					40					
14000RCK	41					27	160	38		N114000LCK	
	46					30					
	50					32					
	55					35					
	60					38					
	65					35					

HCK hex drive heads

Unit : mm

HCK Model	Size (W)		L1	φD1	Applicable torque wrench	
	Size (H)					
230HCK	2.5	19	45	10	N160-230LCK N160-250SPCK N1250FCK, DTC-50EXL, 100EXL	DTC-P140EXL DTC-P180EXL DTC-N5EXL DTC-N10EXL
	3	22				
	4	25				
	5	30				
	6	35				
	8	40				
450HCK	4	27	55	12	N1450LCK N1450-500SPCK N1500FCK DTC-500EXL	DTC-P1400EXL DTC-N50EXL
	5	30				
	6	35				
	8	40				
	10	45				
	6	35				
900HCK	8	40	65	15	N1900LCK N1900-1000SPCK N11000FCK DTC-1000EXL	DTC-P1800EXL DTC-N100EXL
	10	45				
	12	51				
	14	63				
1800HCK	8	40	80	18	N11800LCK N11800-2000SPCK N11500FCK DTC-2000EXL	DTC-P1100EXL DTC-N200EXL
	10	45				
	12	51				
	14	63				
	17	72				
2800HCK	12	51	100	22	N12800LCK, SPCK N12300FCK DTC-3000EXL	DTC-P1200EXL DTC-N300EXL
	14	63				
	17	71				
	19	80				

QCK ratchet heads

Unit : mm

QCK Model	Sq. drive	Size (W)			R	L1	φD1	Applicable torque wrench	
		S	H	G					
120QCK	6.35 (1/4")	24	19	7.5	12	45	10	N160-230LCK N160-250SPCK N1250FCK, DTC-50EXL, 100EXL	DTC-P140EXL DTC-P180EXL DTC-N5EXL DTC-N10EXL
230QCK	9.53 (3/8")	31	25	11	15.5	55	12	N1450LCK N1450-500SPCK N1500FCK, DTC-500EXL	DTC-P1400EXL DTC-N50EXL
450QCK	12.7 (1/2")	39	31	14	19.5				
900QCK	12.7 (1/2")	46	33	14	23				
1800QCK		52	41	14	26				
2800QCK		52	41	14	26	100	22	N12800LCK, SPCK N12300FCK, DTC-3000EXL	DTC-P1200EXL DTC-N300EXL
4200QCK		68	50	20	34	125	25	N14200LCK, N14200SPCK	
4400QCK	19.05 (3/4")	54	42.5	14	27	100	22	N14400LCK, N14400SPCK	
7000QCK		68	50	20	34	125	30	N15600LCK N15600SPCK, DTC-5000EXL	DTC-P1400EXL DTC-N500EXL
10000QCK		76	58	27	38	130	34	N18500LCK N110000FCK, DTC-10000EXL	DTC-P1800EXL DTC-N1000EXL
14000QCK	25.4 (1")	87	61	27	43.5	160	38	N114000LCK	

QLK-LR LARGE HUB NUT TORQUE WRENCHES

Ideal for tightening hub nuts on large trucks and buses

FEATURES

- Dual square drives for both clockwise and counterclockwise tightening.
- By replacing the sockets, various sizes of fasteners can be tightened within the tool's capacity range.
- By reversing the switch on the ratchet, the wrench can be used to loosen fasteners. Tightening to a torque setting, however, can only be done in the direction of the arrow.
- Accuracy : $\pm 3\%$ of indicated value over the full range

USING A QLK-LR WRENCH

- (1) When applicable, mount the extension bar snugly all the way onto the body of the wrench.
- (2) With the extension bar mounted (See Fig. 1) insert the hexagonal end of the adjusting box wrench.
- Without the extension bar (See Fig. 2), insert the hexagonal end of the adjusting box wrench into the body.
- (3) Turn the adjusting box wrench to set the torque value. (Add the sub-scale to the main scale.)

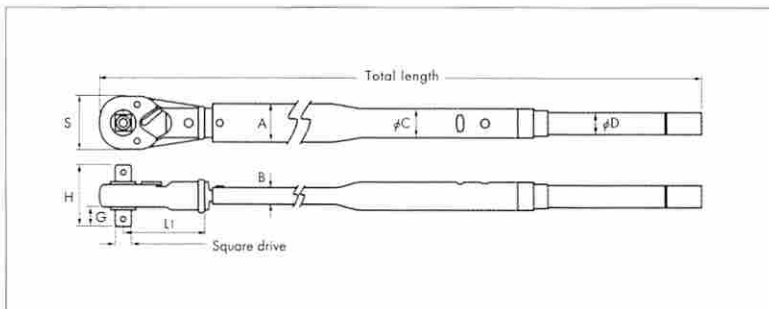
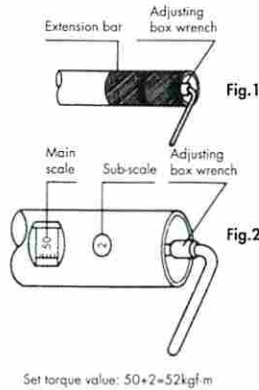

QLK-LR Model	Applicable torque wrench	Square drive mm
7000QLK-LR	(N)5600~7000LCK	19.05 (3/4")
8500QLK-LR	(N)8500~10000LCK	25.4 (1")



QLK-LR Model	Range kgf-m	Increment	N-QLK-LR Model	Range	Increment	Square drive	Total length	Dimensions (mm)								Weight kg	Standard Accessory				
								N-m				Head						Body			
								mm	mm	S	G	H	L1	A	B			φC	φD		
7000QLK-LR	10~70	0.5	N7000QLK-LR	100~700	5	19.05 (3/4")	1,314	68	20	70	125	49	20	35.4	27.2	6.2	Torque adjusting box wrench				
8500QLK-LR	10~85		N8500QLK-LR	100~850		25.4 (1")	1,388	76	27	85	168	54	23	42.7	31.8	8.5					
10000QLK-LR	10~100		N10000QLK-LR	100~1000		1,538	8.8														

FK INDICATOR PLATE TORQUE WRENCHES

Quite suitable for general tightening and for checking torque on previously tightened joints. A popular series with fan-shaped indicator plate scales.

FEATURES

- The simple structure and small friction area give this series of tools a long life.
- Strong and easy to handle.
- Accuracy : $\pm 3\%$ of indicated value over the full range

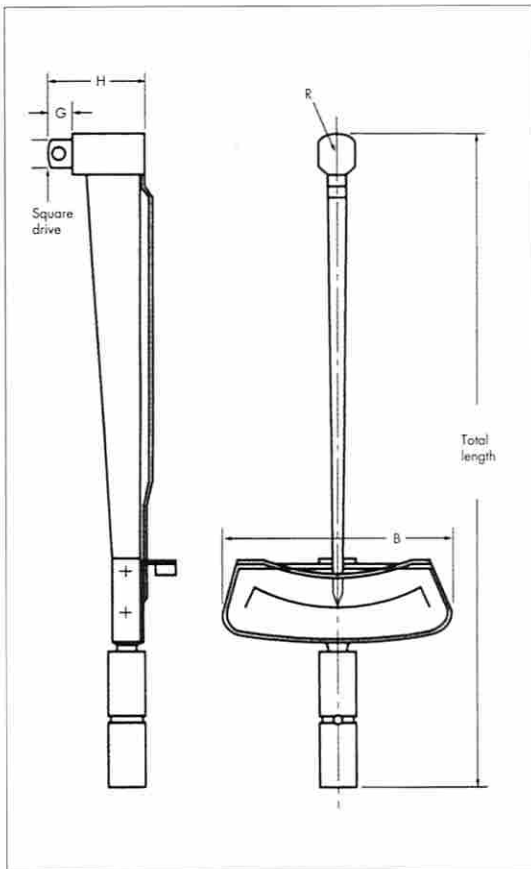

FK

Model FK	Range (CW/CCW)	Increment	Model N-FK	Range (CW/CCW)	Increment	Sq. drive	Total length	Dimensions (mm)					Weight
								Head			B	kg	
								H	G	R			
	kgf-cm			cN-m/N-m		mm	mm						
4FK	1~4	0.2	N4FK	10~40 cN-m	2 cN-m	6.35 (1/4")	110	26	7.5	5	54	0.05	
7FK	1~7	0.2	N7FK	10~70 "	2 "		132						
15FK	5~15	0.5	N15FK	50~150 "	5 "		140						
30FK	10~30	1	N30FK	1~3 N-m	0.1 N-m		170						
60FK	10~60	2	N60FK	1~6 "	0.2 "		190						
120FK	20~120	5	N120FK	2~12 "	0.5 "	237	43.5	6	85	0.25			
230FK	30~230	5	N230FK	3~23 "	0.5 "	9.53 (3/8")	290	42	11	9	106	0.3	
450FK	50~450	10	N450FK	5~45 "	1 "	320							
900FK	100~900	20	N900FK	10~90 "	2 "	12.7 (1/2")	388	58	14	12.5	114	1.1	
1300FK	200~1,300	20	N1300FK	20~130 "	2 "		441						
1800FK	300~1,800	50	N1800FK	30~180 "	5 "		487						
2800FK	500~2,800	50	N2800FK	50~280 "	5 "		587						
4200FK	700~4,200	100	N4200FK	70~420 "	10 "		853						
5600FK	1,000~5,600	100	N5600FK	100~560 "	10 "	19.05 (3/4")	946	48	20	28	186	3.5	
7000FK	1,000~7,000	100	N7000FK	100~700 "	10 "		1172						
8500FK	1,500~8,500	200	N8500FK	150~850 "	20 "		1387						
10000FK	2,000~10,000	200	N10000FK	200~1,000 "	20 "		1578						
15000FK	3,000~15,000	200	N15000FK	300~1,500 "	20 "		1973						
								76.5	27	37	241	8.0	
										43		13.3	
										50		17.0	

TMK DIAL INDICATOR TORQUE WRENCHES

Easy to read dial indicator.
Well suited for inspection and general maintenance service.

FEATURES

- Both peak and standard indicator types are available.
- Easily readable for inspections.
- Useful for general tightening work.
- Accuracy : $\pm 3\%$ of indicated value over the full range
- If you would like TMK with a peak indicator, please specify "TMK-G" on your purchase order. ex). N14000TMK-G

USING A TMK WRENCH

(1) Turn the dial cap and set the indicator to 0.



(2) Mount a socket on the square drive.



(3) Tighten until the indicator points to the desired torque.

- * When using a peak indicator wrench, set it to 0 before tightening.

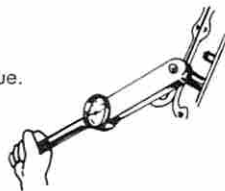

TMK-G (with peak indicator)

* Peak indicator is optional

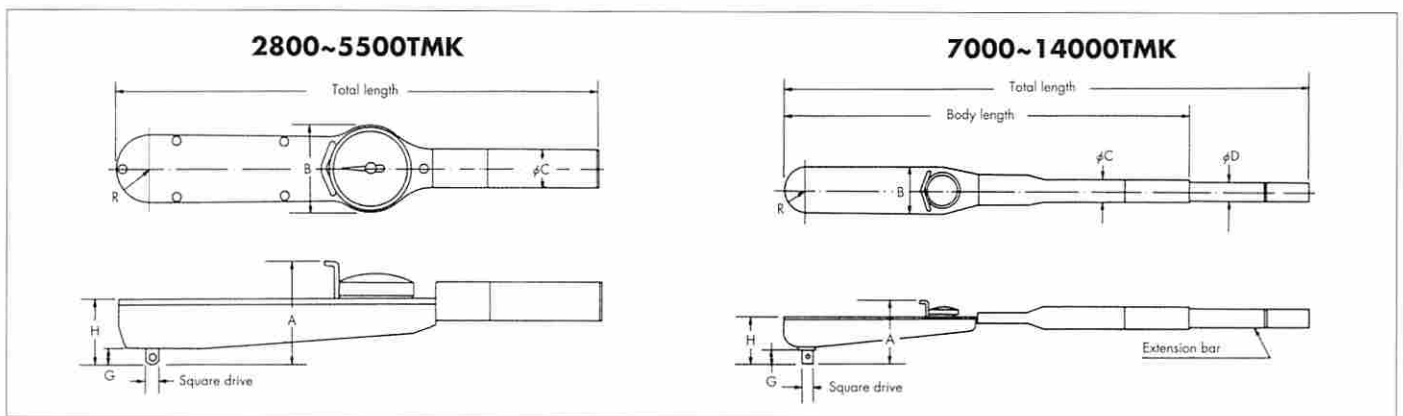

TMK Model	Range (CW/CCW) kgf·m	Increment	N-TMK Model	Range (CW/CCW) N·m	Increment	Sq. drive mm	Total length mm	Dimensions (mm)								Body length	Weight kg	
								Head			Body							
2800TMK	3~28	0.5 kgf·m	N2800TMK	30~280	5	12.7 (1/2")	680	H	G	R	A	B	C	D	765	1.3		
4000TMK	4~40	1 "	N4000TMK	40~400	10		900	56	14	25	87	65	25.4	76			2.2	
5500TMK	5~55	1 "	N5500TMK	50~550			1100	76	35	115	80	32	77					2.6
7000TMK	7~70	1 "	N7000TMK	70~700			1270	116	80	32	765	7.2						
8500TMK	10~85	1 "	N8500TMK	100~850	1400	86	27	40	125	91			40	32	895	7.8		
10000TMK	10~100	2 "	N10000TMK	100~1000	1560	25.4 (1")	1560	88	27	40	125	91	40	32			8.5	
14000TMK	20~140	2 "	N14000TMK	200~1400	1600		1600	88										

* Attachment : Extension bar (7000~14000)

TOK DIAL INDICATOR TORQUE WRENCHES

Easy to read dial indicator.
Well suited for inspection and general maintenance service.

FEATURES

- Oval design with comfort rubber grip reduces strain.
- Easily readable for inspections.
- Useful for general tightening work.
- Accuracy : $\pm 3\%$ of indicated value over the full range

USING A TOK WRENCH

- (1) Turn the dial cap and set the indicator to 0.
- (2) Mount a socket on the square drive.
- (3) Tighten until the indicator points to the desired torque.
 - * When using a peak indicator wrench, set it to 0 before tightening.

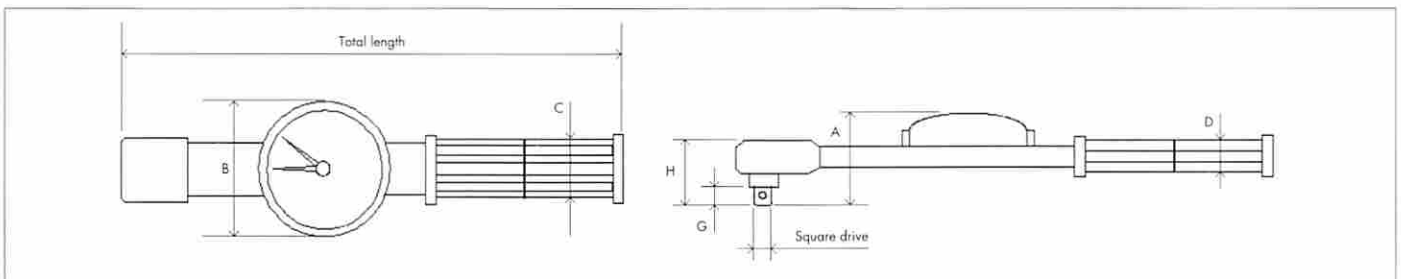
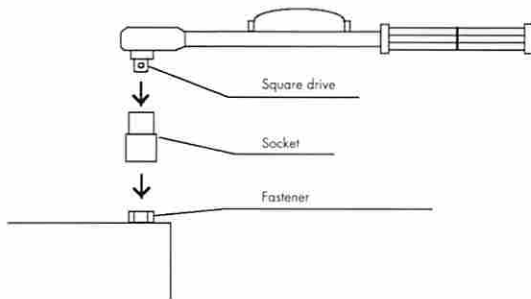

Model	Range (CW/CCW)	Increment	Model	Range (CW/CCW)	Increment	Model	Range (CW/CCW)	Increment	Square drive	Total length	Dimensions (mm)						Weight			
											kgf-cm		N-m		lbf-in/lbf-ft			mm		
											H	G	A	B	C	D	g			
60TOK	6-60	1	N6TOK	0.6-6	0.1	PI50TOK	10-50 lbf-in	1 lbf-in	6.35 (1/4")	260	38.5	7.5	56	68	37	21.5	504			
120TOK	10-120	2	N12TOK	1-12	0.2	PI100TOK	20-100 "	2 "												508
300TOK	50-300	5	N30TOK	5-30	0.5	PI250TOK	50-250 "	5 "												614
700TOK	100-700	10	N70TOK	10-70	1	PI600TOK	100-600 "	10 "												
1400TOK	200-1400	20	N140TOK	20-140	2	PF100TOK	20-100 lbf-ft	2 lbf-ft	12.7 (1/2")	463	49	14	63		41	22.5	865			
2000TOK	200-2000	20	N200TOK	20-200	2															

LTDK CLUTCH RELEASE TORQUE SCREW DRIVERS

Clutch release prevents over-tightening, reduces fatigue.

FEATURES

- Comfortable grip for extended use.
- Light weight and short overall length facilitates jobs.
Sensitive clutch release helps the operator feel when the torque setting is reached.
- Set the required torque value and tighten, all operators tighten consistently.
- Two Phillips bit are included.
- Various hex and box drive bits are available.
- Use for both clockwise and counter-clockwise tightening.
- Accuracy : $\pm 3\%$ of indicated value over the full range, clockwise.
- "H" models accept standard bits instead of CB type bits.

USING AN LTKD DRIVER

- (1) Select and mount a bit to match the fastener.
- (2) Rotate the adjusting ring and set the desired torque.
- (3) Tighten the fastener clock-wise until the clutch releases and there is no more resistance.



N6~50LTKD

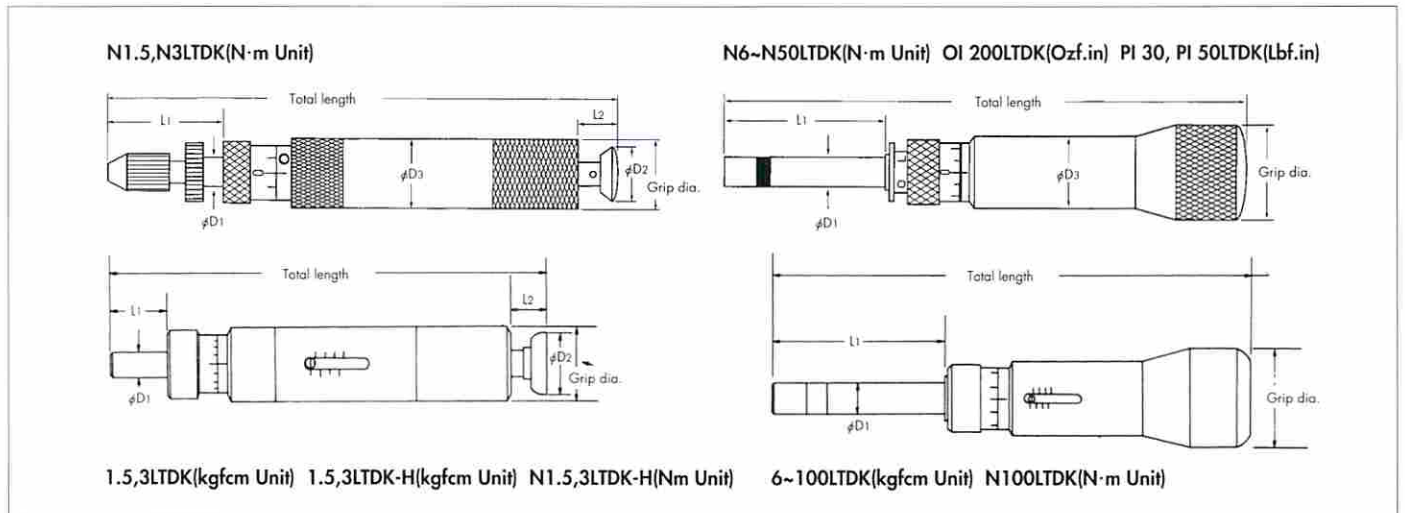

Model N-LTKD	Range	Increment	Model OI·PI-LTKD	Range	Increment	Grip dia.	Total length (without bit)	Dimensions (mm)					Weight	Attachment Bits						
								Body						g	Bits					
	cN·m/N·m			ozf·in/lbf·in		φmm	mm	L1	L2	φD1	φD2	φD3			Phillips	Bit type				
N1.5LTKD	1~15	0.1				16	107	22				16	57	No.0	KANON bits CB type					
N3LTKD	2~30	0.2											192	No.1						
N6LTKD	5~60	0.5				25	110	26				20	99	No.0	Standard bits SB type					
N12LTKD	20~120	1	OI 200LTKD	40~200	1	30	157	51	10	10.5	5.5	14.4	25	214		No.1				
N20LTKD	40~200	1																		
N30LTKD	40~300	1	PI 30LTKD	4~30	0.1	34														
N50LTKD	100~500	2.5	PI 50LTKD	10~50	0.25	40	200	63									34	436	No.2	
N100LTKD	4~10	0.05				45	235	100								11	35	762	No.2, No.3	

Model LTDK/LTDK-H	Range	Increment	Grip dia.	Total length (without bit)	Dimensions (mm)					Weight	Attachment	
					Body						Bits	
					L1	L2	φD1	φD2	φD3		g	Phillips
1.5LTDK	0.1~1.5 kgf·cm	0.01 kgf·cm	16	99	14	9	5.5	14.4	20	50	No.0	KANON bits OB type
3LTDK	0.2~3 -	0.02 -										
6LTDK	0.5~6 -	0.05 -	25	110	35				25	95	No.0	
12LTDK	2~12 -	0.1 -										
20LTDK	4~20 -	0.1 -	34	157	57				34	190	No.1	
30LTDK	4~30 -	0.1 -										
50LTDK	10~50 -	0.25 -	40	200	73				35	208	No.1	
100LTDK	40~100 -	0.5 -										
1.5LTDK-H	0.1~1.5 -	0.01 -	16	111	26	9	10	14.4	35	60	No.0	Standard bits SB type
3LTDK-H	0.2~3 -	0.02 -										
N1.5LTDK-H	1~15 cN·m	0.1 cN·m									No.1	
N3LTDK-H	2~30 -	0.2 -									No.2, No.3	

STDK PRE-SET TORQUE DRIVERS

Clutch release prevents over tightening.

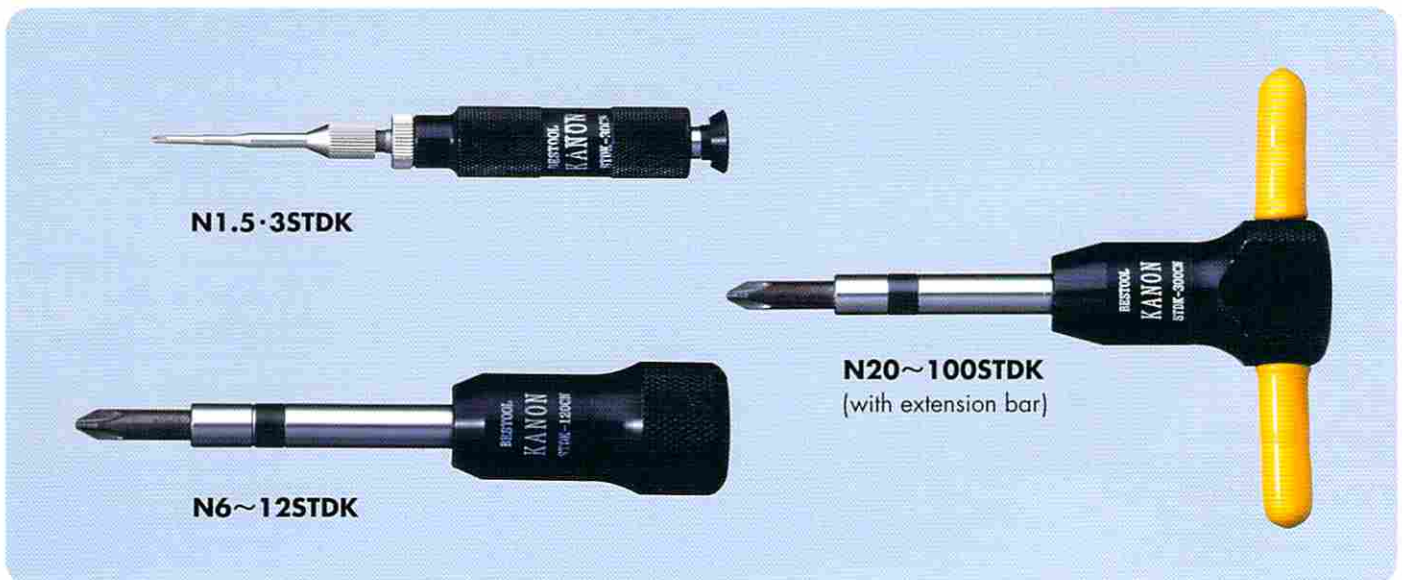

FEATURES

- A single function driver, used for a single torque setting.
 - Most suited for tightening multiple same-size fasteners at the same torque in a production line.
 - Setting confirmation unnecessary.
 - Light weight and short overall length facilitates jobs.
Sensitive clutch release helps the operator feel when the torque setting is reached.
 - All operators tighten consistently.
 - Two Phillips bit are included.
 - Various hex and box drive bits are available.
 - Accuracy : ±3% of set value, clockwise.
- * Please specify required set torque when you order.

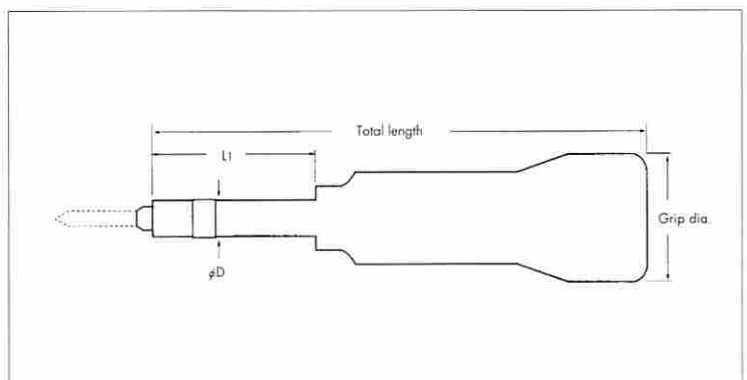

Model STDK	Range	Model N-STDK	Range	Model OI-PI-STDK	Range	Grip dia.	Total length (without bit)	Dimensions (mm)		Weight	Included Accessory	
								Body			Bits	
								ozf-in/lbf-in	φmm		L1	φD
1.5STDK	0.1~1.5	N1.5STDK	1~15 cN·m	OI 22STDK	2~22 ozf-in	16	92	22	8	45	No.0	KANON bits CB type
3STDK	0.2~3	N3STDK	2~30 -	OI 44STDK	4~44 -							
6STDK	0.5~6	N6STDK	5~60 -	OI 80STDK	10~80 -	25	102	40		94	No.0	
12STDK	2~12	N12STDK	20~120 -	OI 200STDK	40~200 -							
20STDK	4~20	N20STDK	40~200 -	PI 20STDK	4~20 lbf-in	30	116	54	10	148	No.1	
30STDK	4~30	N30STDK	40~300 -	PI 30STDK	4~30 -							
50STDK	10~50	N50STDK	100~500 -	PI 50STDK	10~50 -	35	117	52		170	No.1	
100STDK	20~100	N100STDK	2~10 N·m	PI 100STDK	20~100 -							
						45	235	100	11	790	No.2, No.3	Standard bits SB type

DPSK DIAL GAUGE TORQUE DRIVERS

Suited for light torque, general tightening work, inspections and break tests. Easy to handle, easy to read scale.



FEATURES

DPSK (standard)

- A light torque driver well suited for general tightening, inspections and break tests.
- Easy handling with a direct reading dial gauge.
- Use for both clockwise and counterclockwise tightening.
- Peak torque indicator works in both directions, too.
- Large, easily read dial gauge.

DPSK II (transparent scale)

- The transparent scale makes engaging the fastener easier.
- For both models, accuracy is $\pm 3\%$ of the indicated value over the full range

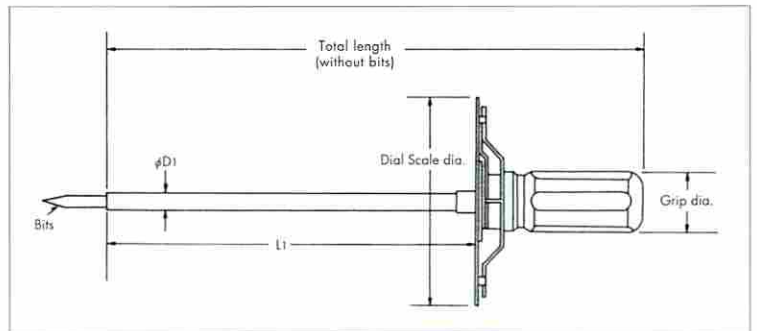

USING A DPSK DRIVER

- (1) Mount a bit matching the fastener being
- (2) Loosen the peak indicator ring.
- (3) Set the peak indicator to 0.
- (4) Tighten the fastener while observing the scale.

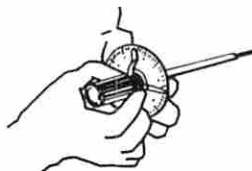

Model DPSK	Range (CW/CCW)	Increment	Model N-DPSK	Range (CW/CCW)	Increment	Dial dia.	Grip dia.	Total length (without bit)	Dimensions (mm)		Weight	Included Accessory Bits				
						ϕ mm	ϕ mm		mm	ϕ D1		kg	Phillips	Bit type		
1DPSK	0.2~1	0.025	N1DPSK	2~10 cN·m	0.25 cN·m	78	22	217	152	6	0.075	No.0 No.1	KANON bits OB type			
2DPSK	0.5~2	0.05	N2DPSK	5~20 -	0.5 -			195	130							
5DPSK	1~5	0.2	N5DPSK	10~50 -	2 -			208	143							
10DPSK	2~10	0.2	N10DPSK	20~100 -	2 -			222	130							
20DPSK	5~20	0.5	N20DPSK	0.5~2 N·m	0.05 N·m			242	12							
50DPSK	10~50	2	N50DPSK	1~5 -	0.2 -	36	300	188	14	0.47	No.1 No.2	Standard bits SB type				
10DPSK(II)	2~10	0.2	N10DPSK(II)	20~100 cN·m	2 cN·m	78	33	222	130	12			0.29			
20DPSK(II)	5~20	0.5	N20DPSK(II)	0.5~2 N·m	0.05 N·m									242	0.32	
50DPSK(II)	10~50	2	N50DPSK(II)	1~5 -	0.2 -											36

SGK TORQUE GAUGES

Capable of accurately measuring very low torque values.

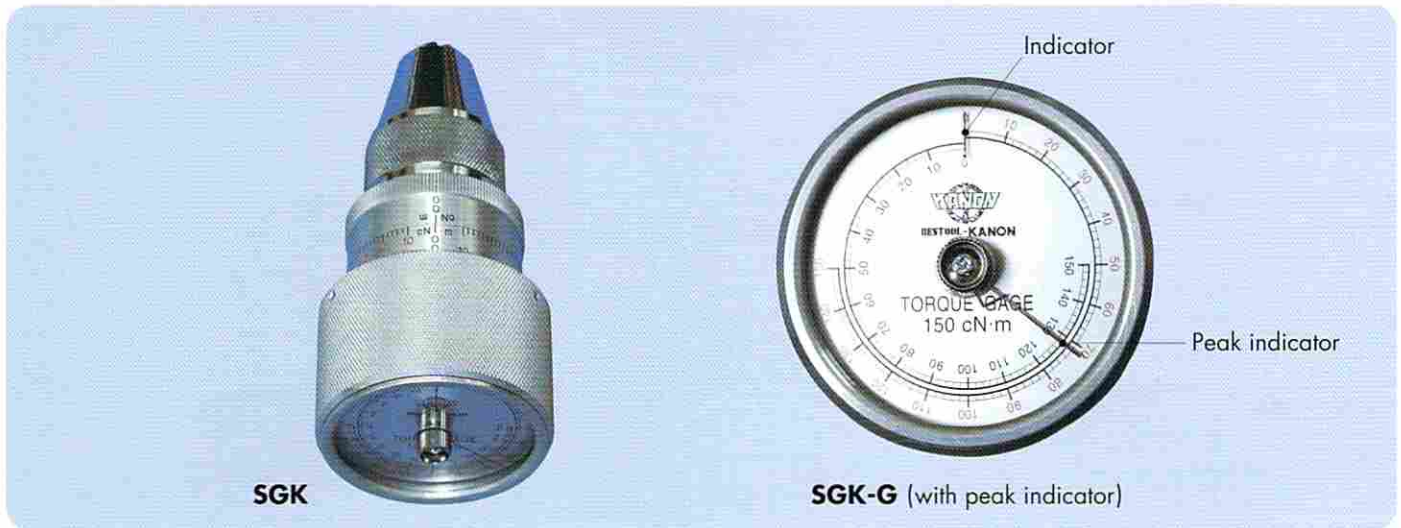

* Peak indicator is optional

FEATURES

- Due to their miniature design and light weight, these gauges are convenient and easy to carry.
- A three part chuck with knurled surface enables firmly gripping even odd shapes.
- The inset scale face helps avoid incidental damage.
- The gauges measure clockwise and counterclockwise.
- With scales on the sides and the face, torque readings can be obtained either way.
- Accuracy : $\pm 3\%$ of the indicated value over the full range

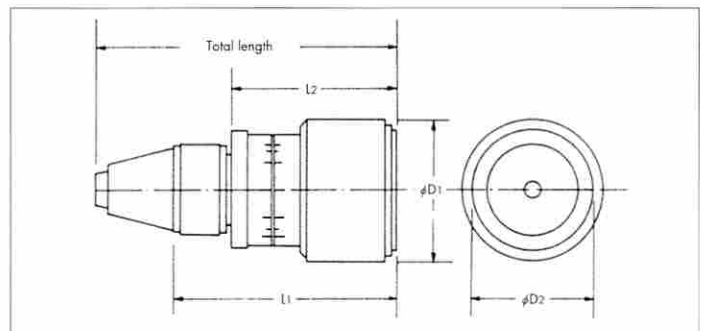

USING AN SGK GAUGE

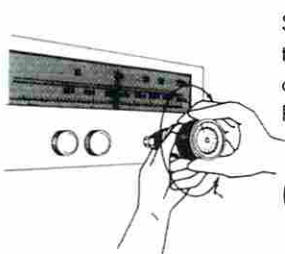

Starting torque can be measured with the chuck gripping a knob or shaft of an electronic device. Rotate clockwise or counterclockwise.

(Rotate CW or CCW)



- If you would like SGK with a peak indicator, please specify "SGK-G" on your purchase order.
ex). N150(I)SGK-G

Three part chuck

Model SGK	Range (CW/CCW) gf-cm / kgf-cm	Increment	Model N-SGK	Range (CW/CCW) mN-m / cN-m	Increment	Chucking dia. φ mm	Total length mm	Dimensions (mm)				Weight kg
								Grip dia.		Total length (without chuck)		
								φD1	φD2	L1	L2	
90 (I) SGK	10~90 gf-cm	2 gf-cm	N90 (I) SGK	1~9 mN-m	0.2mN-m	1-6.5	106	43	36	83	57.5	0.29
150 (I) SGK	20~150 -	2 -	N150 (I) SGK	2~15 -	0.2 -							
300 (I) SGK	40~300 -	5 -	N300 (I) SGK	4~30 -	0.5 -							
600 (I) SGK	50~600 -	10 -	N600 (I) SGK	5~60 -	1 -							
1200 (I) SGK	100~1200 -	20 -	N1200 (I) SGK	10~120 -	2 -							
2400 (I) SGK	200~2400 -	50 -	N2400 (I) SGK	20~240 -	5 -	1-8.5	132	63	53	102	72	0.6
1.5 (II) SGK	0.1~1.5 kgf-cm	0.02 kgf-cm	N1.5 (II) SGK	1~15 cN-m	0.2 cN-m							
2.4 (II) SGK	0.2~2.4 -	0.02 -	N2.4 (II) SGK	2~24 -	0.2 -							
3.6 (II) SGK	0.4~3.6 -	0.05 -	N3.6 (II) SGK	4~36 -	0.5 -							
6 (II) SGK	0.5~6 -	0.1 -	N6 (II) SGK	5~60 -	1 -							
9 (II) SGK	1~9 -	0.2 -	N9 (II) SGK	10~90 -	2 -							
15 (II) SGK	1~15 -	0.2 -	N15 (II) SGK	10~150 -	2 -							

KDTA-SV DIGITAL TORQUE ANALYZERS

Enhanced digital processor system. Provides high performance with digital wrenches.

FEATURES

- LED display eliminates reading errors.
- Processor chip assures measurement with high reliability and accuracy.
- The display unit angle can be adjusted approximately 90°.
- Can be connected to various optional equipment (printer, personal computer, external input keyboard).
- Saves time and helps speed up work.
- Equipped with a kgf-cm/N-m selector switch.
- Operator can set min/max percentage parameters from 0-10%.
- Analyzer can indicate in or out of specification with a green or red lamp respectively.

SPECIFICATIONS

- Power source : AC100-240V 50/60Hz
- Accuracy : ±1% of the indicated value +1 increment, over the full range
- Display : red LED (character height : 25mm)
- Operating temperature : 5~35°C



KDTA-2000SV

Model	Range(CW/CCW)		English Model	Range(CW/CCW)		Measuring mode	Unit conversion	Dimensions (mm)			Drive size mm	Weight kg	Included Accessory
	kgf-cm/kgf-m	Increment		lbf-in	Increment			Overall depth	Overall width	Overall height			
KDTA-20SV	2-20 kgf-cm	0.01 kgf-cm	KDTA-20SV	1.77-17.70 lbf-in	0.01 lbf-in	RUN Peak hold Peak to peak hold	Standard kgf-cm N-m English Model lb-in N-m	120	250	240	12	6	6.35×12 Socket
	20-200 cN-m	0.1 cN-m			20-200 cN-m								
KDTA-100SV	10-100 kgf-cm	0.1 kgf-cm	KDTA-100SV	8.9-88.5 lbf-in	0.1 lbf-in								
	1-10 N-m	0.01 N-m			1-10 N-m								
KDTA-200SV	20-200 kgf-cm	0.1 kgf-cm	KDTA-200SV	17.7-177.0 lbf-in	0.1 lbf-in								
	2-20 N-m	0.01 N-m			2-20 N-m								
KDTA-1000SV	100-1000 kgf-cm	1 kgf-cm	KDTA-1000SV	89-885 lbf-in	1 lbf-in			180	320	273	14	15	9.5×14 12.7×14 Socket
	10-100 N-m	0.1 N-m			10-100 N-m								
KDTA-2000SV	200-2000 kgf-cm	1 kgf-cm	KDTA-2000SV	177-1770 lbf-in	1 lbf-in								
	20-200 N-m	0.1 N-m			20-200 N-m			0.1 N-m					
KDTA-6000SV	600-6000 kgf-cm	1 kgf-cm				220	380	265	26	25	19.05×26 25.4×26 Socket		
	60-600 N-m	0.1 N-m											
KDTA-10000SV	10-100 kgf-m	0.1 kgf-m				30			30		19.05×30 25.4×30 Socket		
	100-1000 N-m	1 N-m											

DRIVE ATTACHMENTS (Optional)

■ KDTA-20SV/100SV/200SV 200SVH



■ KDTA-1000SV/2000SV 1000SVH/2000SVH, 2000SV II



■ KDTA-3000SVH



KDTA-SVH

LARGE DIGITAL TORQUE ANALYZERS

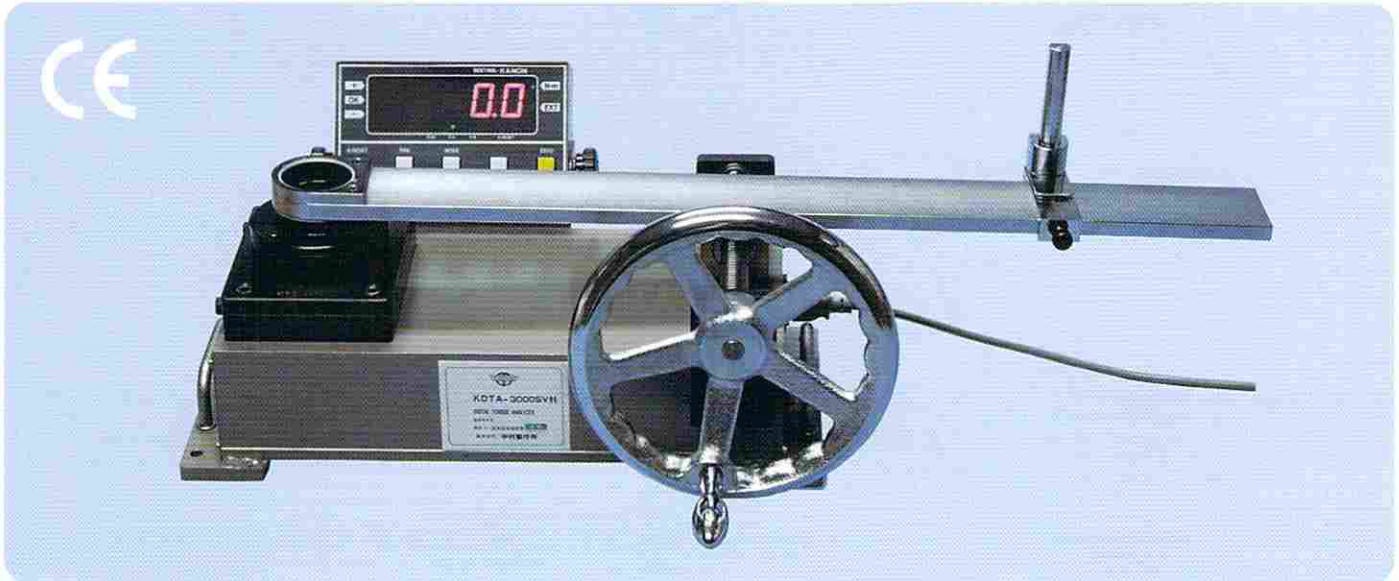

FEATURES

- LED display eliminates reading errors.
- Processor chip assures measurement with high reliability and accuracy.
- The display unit angle can be adjusted approximately 90°.
- Can be connected to various optional equipment (printer, personal computer, external input keyboard).
- Saves time and helps speed up work.
- Equipped with a kgf-cm/N-m selector switch.

SPECIFICATIONS

- Power : AC100-240V 50/60Hz
- Accuracy : $\pm 1\%$ of the indicated value +1 increment, over the full range
- Display : red LED (character height : 25mm)
- Operating temperature range : 5~35°C

Model	Range(CW/CCW)		Increment	English Model	Range(CW/CCW)		Increment	Measuring mode	Unit conversion	Drive size	Weight	Included Accessory
	kgf-cm/kgf-m	N-m			lbf-in/lbf-ft	N-m						
KDTA-200SVH	20~200 kgf-cm	0.1 kgf-cm	KDTA-200SVH	17.7~177.0 lbf-in	0.1 lbf-in	Standard kgf-cm N-m	12	10	6.35×12 Socket			
	2~20 N-m	0.01 N-m		2~20 N-m	0.01 N-m							
KDTA-1000SVH	100~1000 kgf-cm	1 kgf-cm	KDTA-1000SVH	89~885 lbf-in	1 lbf-in	English Model lb-in N-m	14	17.5	9.5×14 Socket			
	10~100 N-m	0.1 N-m		10~100 N-m	0.1 N-m							
KDTA-2000SVH	200~2000 kgf-cm	1 kgf-cm	KDTA-2000SVH	177~1770 lbf-in	1 lbf-in	Standard kgf-cm N-m	22	29	12.7×22 Socket 19.05×22 Socket			
	20~200 N-m	0.1 N-m		20~200 N-m	0.1 N-m							
KDTA-3000SVH	300~3000 kgf-cm	1 kgf-cm	KDTA-3000SVH	22.1~221.2 lbf-ft	0.1 lbf-ft	English Model lb-ft N-m	26	80	12.7×26 Socket 19.05×26 Socket			
	30~300 N-m	0.1 N-m		30~300 N-m	0.1 N-m							
KDTA-6000SVH	600~6000 kgf-cm	1 kgf-cm	KDTA-6000SVH	44.2~442.5 lbf-ft	0.1 lbf-ft	English Model lb-ft N-m	30	65	12.7×30, 19.05×30 25.4×30 Socket			
	60~600 N-m	0.1 N-m		60~600 N-m	0.1 N-m							
KDTA10000SVH	10~100 kgf-m	0.1 kgf-m	KDTA-10000SVH	74~737 lbf-ft	1 lbf-ft							
	100~1000 N-m	1 N-m		100~1000 N-m	1 N-m							

TPK-3

STANDARD PRINTER

FEATURES

- Indicates in or out of specification on the led display and print out.
- * Printer cables are options. CT-1 is for DTC series.
CSV-1 is for KDTA-SV and KDTA-SVH series.



KDTA-SVII DIGITAL TORQUE ANALYZERS

Highly accurate and economical torque analyzer, easy for operators to use on the job site.



FEATURES

- LED display eliminates reading errors.
- Processor chip assures measurement with high reliability and accuracy.
- Connects to an optional printer.
- Saves time and helps speed up work.
- Equipped with a kgf-cm/N-m selector switch.

SPECIFICATIONS

- Power : AC100-240V 50/60Hz
- Accuracy : $\pm 1\%$ of the indicated value + 1 increment, over the full range
- Display : red LED (character height : 25mm)
- Operating temperature range : 5~35°C

Model	Torque measuring range	Increment	English Model	Torque measuring range	Increment	Drive size	Display	Weight (kg)
KDTA-2000SV (II)	50~2000kgf-cm/5~200N-m	1kgf-cm/0.1N-m	KDTA-2000SV (II)	35~1770lb-in/5~200N-m	1lb-in/0.1N-m	14mm	Red LED	11.5

KDTA-SVEX AUTOMATIC DIGITAL TORQUE ANALYZERS

FEATURES

- LED display eliminates reading errors.
- Processor chip assures measurement with high reliability and accuracy.
- Saves time and helps speed up work.
- Equipped with a kgf-cm/N-m selector switch.

SPECIFICATIONS

- Power : AC100-240V 50/60Hz
- Accuracy : $\pm 1\%$ of the indicated value + 1 increment, over the full range
- Display : red LED
- Operating temperature range : 5~35°C

Model	Range(CW/CCW)	Increment	Measuring mode	Unit conversion	Drive size mm	
	kgf-cm/kgf-m N-m					
KDTA-6000SVEX	600~6000 kgf-cm	1 kgf-cm	RUN Peak hold Peak to peak hold	Standard kgf-cm N-m	26	
	60~600 N-m	0.1 N-m				
KDTA-10000SVEX	10~100 kgf-m	0.1 kgf-m			30	
	100~1000 N-m	1 N-m				
KDTA-20000SVEX	20~200 kgf-m	0.1 kgf-m				32
	200~2000 N-m	1 N-m				



* Calibration Test kits are options.

KDTA-DH

DIGITAL TORQUE ANALYZERS FOR TORQUE DRIVERS



KDTA-8DH / KDTA-80DH

FEATURES

- Designed for LTKD and STDK
 - Battery powered
 - Battery Charger with user selectable 100, 120 or 230V A/C adapter
 - Lightweight plastic case
 - kgf-cm/N·m / lbf-in unit conversion
- MODE : RUN (constantly indicates torque value.)
PEAK HOLD
PEAK TO PEAK-HOLD
 - AUTO RESET : Timer function available
 - DATA OUTPUT : Digital output
 - PRINTER : TPK-3 (Optional)
 - Accuracy : $\pm 1\%$ of the indicated value + 1 increment, over the full range

Model	Range	Increment	Measuring mode	Battery	Size	Weight (g)
KDTA-8DH	3~800mN·m 0.03~8kgf·cm 0.03~7lbf·in	0.1mN·m 0.001kgf·cm 0.001lbf·in	RUN Peak hold Peak to Peak hold	Rechargeable	230 (W) × 123 (D) × 65 (H) mm	830
KDTA-80DH	3~800cN·m 0.3~80kgf·cm 0.3~70lbf·in	0.1cN·m 0.01kgf·cm 0.01lbf·in	RUN Peak hold Peak to Peak hold	Rechargeable	230 (W) × 123 (D) × 65 (H) mm	830

KDTA-D

DIGITAL TORQUE ANALYZERS FOR ELECTRIC DRIVERS

KDTA-10D / KDTA-100D

FEATURES

- Battery is rechargeable.
 - For any brand of the Electric Driver
 - Battery Charger is available for AC100V~230V50/60H.
- MODE : RUN (constantly indicates torque value.)
PEAK HOLD
PEAK TO PEAK-HOLD
 - AUTO RESET : Timer function available
 - DATA OUTPUT : Digital output
 - PRINTER : TPK-3 (Optional)
 - Accuracy : $\pm 1\%$ of the indicated value + 1 increment, over the full range



Model	Range	Increment	Measuring mode	Battery	Size	Weight (g)
KDTA-10D	1.5~100.0cN·m 0.15~10.00kgf·cm 0.13~10.00lbf·in	0.1cN·m 0.01kgf·cm 0.01lbf·in	RUN Peak hold Peak to Peak hold	Rechargeable	230 (W) × 123 (D) × 65 (H) mm	1,100
KDTA-100D	15~1000cN·m 1.5~100.0kgf·cm 1.3~100.0lbf·in	1cN·m 0.1kgf·cm 0.1lbf·in	RUN Peak hold Peak to Peak hold	Rechargeable	230 (W) × 123 (D) × 65 (H) mm	1,100

CTK-XL CAP TESTER

DIGITAL CAP TORQUE ANALYZERS

Digital measurement of opening and closing torque on container caps.



CTK-XL

* The bottle is not included.

FEATURES

- Optimal for measuring torque values opening or closing caps on containers for cosmetic products, medical products, foods, etc.
- Up to 100 measurements can be stored in memory.
- Upper and lower limit values can be set.
- Capable of measuring clockwise and counterclockwise values.
- The testers will handle containers in diameters ranging 10~100mm and 22~180mm.
- Accuracy : $\pm 1\%$ of indicated value +1 increment, over the full range

MODE : Power source ON/OFF switch, MODE selection

CLR : [0] reset switch, data cleared

UP : Upper limit value set switch

DW : Lower limit value set switch

SET : save data



Model	Torque range	Increment	Accuracy	Power source	Weight	Chuck diameter (mm)
CTK-30XL	3~30kgf·cm	0.02kgf·cm	$\pm 1\%$ of indicated value +1 increment over the full range	AC100~240V (adapter DC6V)	11kg	$\phi 10\sim\phi 100$
CTK-100XL	10~100kgf·cm	0.1kgf·cm				$\phi 22\sim\phi 180$
CTK-3NXL	30~300cN·m	0.2cN·m	$\pm 1\%$ of indicated value +1 increment over the full range	AC100~240V (adapter DC6V)	11kg	$\phi 10\sim\phi 100$
CTK-10NXL	1~10N·m	0.01N·m				$\phi 22\sim\phi 180$

TK TENSION GAUGES

Demonstrating KANON's measuring versatility.
Great performance whether measuring vertically or horizontally.

FEATURES

- Measures pushing, pulling force and spring tension.
Our tension gauges are designed to indicate precise increments of force.
- Use the gauges for taking horizontal measurements. Just add the correcting value to the indicated value (see the table below). A peak indicator is available on every model.
- Accuracy : ± 1 increment

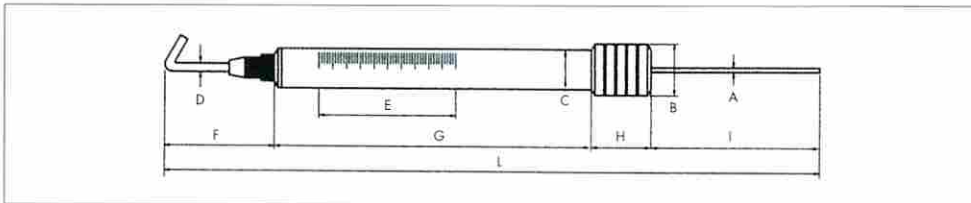

Model (g)	Range (g)	Incr. (g)	A mm	B mm	C mm	D mm	E mm	F mm	G mm	H mm	I mm	L mm	Weight (g)	Correcting value for horizontal measurements (g)
TK10	0 ~ 10	0.5	1.5	16	13	1.5	40	19	98	15	48	180	30	3
TK30	0 ~ 30	1	1.5	16	13	1.5	60	19	113	15	66	213	30	3
TK50	0 ~ 50	1	1.5	16	13	1.5	60	19	113	15	66	213	30	3
TK110	0 ~ 110	2	2	16	13	2	60	27.5	113	15	65.5	221	35	10
TK200	0 ~ 200	5	2	16	13	2	60	27.5	113	15	65.5	221	35	10
TK300	0 ~ 300	5	2	16	13	2	60	27.5	113	15	65.5	221	35	10
TK500	0 ~ 500	10	3	20	16	2.6	56	43	131	25	69	268	78	30
TK600	0 ~ 600	20	3	20	16	2.6	56	43	131	25	69	268	78	30
TK1000	0 ~ 1000	25	3	20	16	2.6	56	43	131	25	69	268	78	30
TK1500	0 ~ 1500	50	3	20	16	2.6	56	43	131	25	69	268	78	30
TK2000	0 ~ 2000	50	3	20	16	2.6	56	43	131	25	69	268	78	30
TK2500	0 ~ 2500	50	3	20	16	2.6	62	43	143	25	74	285	85	50
TK3000	0 ~ 3000	50	3	20	16	2.6	62	43	143	25	74	285	85	50
TK4000	0 ~ 4000	50	4	25	22	3.5	68	43	178	35	82	338	200	100
TK5000	0 ~ 5000	100	4	25	22	3.5	68	43	178	35	82	338	200	100
TK7000	0 ~ 7000	200	4	25	22	3.5	68	43	178	35	82	338	205	100
TK10000	0 ~ 10000	200	4	25	22	3.5	68	43	178	35	82	338	205	100
TK15000	0 ~ 15000	200	8	35	32	7	95	83	230	35	145	493	600	250
TK20000	0 ~ 20000	200	8	35	32	7	118	83	280	35	140	538	680	250
TK30000	0 ~ 30000	500	8	40	38	7	130	83	305	35	172	595	830	350

Model (cN)	Range (cN)	Incr. (cN)	A mm	B mm	C mm	D mm	E mm	F mm	G mm	H mm	I mm	L mm	Weight (g)	Correcting value for horizontal measurements (c-N)
TK10cN	0 ~ 10	0.5	1.5	16	13	1.5	40	19	98	15	48	180	30	3
TK30cN	0 ~ 30	1	1.5	16	13	1.5	60	19	113	15	66	213	30	3
TK50cN	0 ~ 50	1	1.5	16	13	1.5	60	19	113	15	66	213	30	3
TK110cN	0 ~ 110	2	2	16	13	2	60	27.5	113	15	65.5	221	35	10
TK200cN	0 ~ 200	5	2	16	13	2	60	27.5	113	15	65.5	221	35	10
TK300cN	0 ~ 300	5	2	16	13	2	60	27.5	113	15	65.5	221	35	10
TK500cN	0 ~ 500	10	3	20	16	2.6	56	43	131	25	69	268	78	30
TK600cN	0 ~ 600	20	3	20	16	2.6	56	43	131	25	69	268	78	30
TK1000cN	0 ~ 1000	25	3	20	16	2.6	56	43	131	25	69	268	78	30
TK1500cN	0 ~ 1500	50	3	20	16	2.6	56	43	131	25	69	268	78	30
TK2000cN	0 ~ 2000	50	3	20	16	2.6	56	43	131	25	69	268	78	30
TK2500cN	0 ~ 2500	50	3	20	16	2.6	62	43	143	25	74	285	85	50
TK3000cN	0 ~ 3000	50	3	20	16	2.6	62	43	143	25	74	285	85	50
TK4000cN	0 ~ 4000	50	4	25	22	3.5	68	43	178	35	82	338	200	100
TK5000cN	0 ~ 5000	100	4	25	22	3.5	68	43	178	35	82	338	200	100
TK7000cN	0 ~ 7000	200	4	25	22	3.5	68	43	178	35	82	338	205	100
TK10000cN	0 ~ 10000	200	4	25	22	3.5	68	43	178	35	82	338	205	100
TK15000cN	0 ~ 15000	200	8	35	32	7	95	83	230	35	145	493	600	250
TK20000cN	0 ~ 20000	200	8	35	32	7	118	83	280	35	140	538	680	250
TK30000cN	0 ~ 30000	500	8	40	38	7	130	83	305	35	172	595	830	350



* Peak indicator is optional

- If you take a measurement horizontally, add the correcting value to the indicated measurement value per the table.
- If you would like your TK gauge with a peak indicator, please specify "TK-G" on your purchase order.
ex). TK500cN-G

TCSK-99MA

MULTI-FUNCTION TORQUE TASK MANAGER / ANALYZER

The multi-controller, the "Careless Mistake Detector" has a 100-240V multi-input type power system.



This is an extremely useful multi-function controller that can serve many purposes, such as detecting loose joints, eliminating faulty fastener tightening, and task time management through connection with a KANON torque wrench, or torque driver.

FEATURES

- TCSK-99MA connects to KANON SWP series torque tools.
- The red LED indicators are large and easy-to-read, allowing the operator to check the settings and progress of fastener tightening work at a glance. With visible and audible signals, the TCSK-99MA prevents you from leaving joints loose during fastener tightening work.
- Compared with conventional products, TCSK-99MA offers many different functions at a lower price.
- TCSK-99MA can help manage work processes via external output signals.

* This item does not have the CE mark.

Model	TCSK-99MA
Count	1 to 99
Timer setting	Digital input (set time for each function)
Judgement	OK (sounds and LED lights up in green) NG (sounds and LED lights up in red)
External input	Start, stop, reset, direction of rotation, work, lock
External output	Count OK, work NG/OK, overtime NG, in-time NG
Power supply	Input (primary side), switching power type multi-input of 100 to 240 VAC Output(secondary side) 24VDC, 2A 50W
Power consumption	10W
Outside dimensions	209mm (W)×77mm(H)×180mm(D)
Weight	approximately 1.7kg

SWP Series

TORQUE TOOLS FOR TCSK

SWP tools connect with TCSK-99MA and prevent missing tightening joints.



N-QLK-SWP

FEATURES

- When the tool clicks, indicating the joint is tightened to the specified torque, a signal is sent to the TCSK-99MA.

SWP TYPES ● Type and torque range

Model	Available Models
SPK-SWP	80SPK~ 4200SPK N80SPK~ N4200SPK
RSPK-SWP	80RSPK~ 4200RSPK N80RSPK~ N4200RSPK
QSPK-SWP	PI120QSPK~ PI2800QSPK / PF4200QSPK 120QSPK~ 4200QSPK N120QSPK~ N4200QSPK
SPCK-SWP	120SPCK~ 4200SPCK N120SPCK~ N4200SPCK

- Accuracy : $\pm 3\%$ of pre-set value

QLK-SWP	PI120QLK~ PI2000QLK 120QLK~ 4200QLK N120QLK~ N4200QLK
LCK-SWP	120LCK~ 4200LCK N120LCK~ N4200LCK

- Accuracy : $\pm 3\%$ of indicated value over the full range

LTDK-SWP	OI200LTDK / PI30LTDK~ PI50LTDK 12LTDK~ 100LTDK N12LTDK~ N100LTDK
----------	--



- Accuracy : $\pm 3\%$ of indicated value over the full range, clockwise

* Torque wrench setting of N450QLK-SWP less than 10N·m and 450QLK-SWP less than 100kgf·cm does not go signal properly.

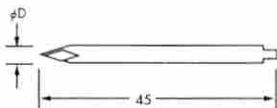
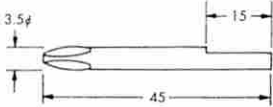
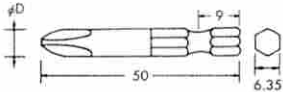
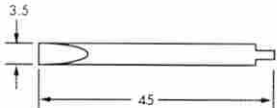
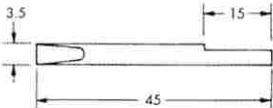
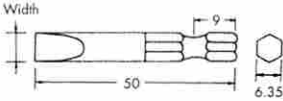

BITS

BITS FOR TORQUE DRIVERS

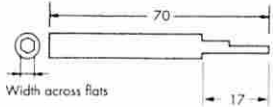
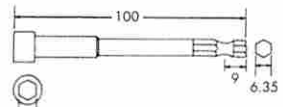
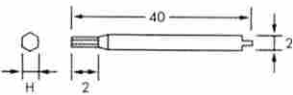
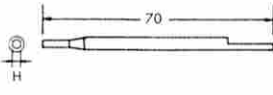
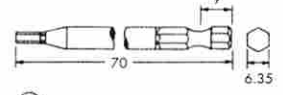
Type	KANON bits CB type	KANON bits OB type	Standard bits SB type																																								
Applicable driver	N1.5, 3 LTKD (N)1.5, 3STDK OI 22, 44, STDK	1.5, 3 LTKD (N) 1, 2, 5 DPSK	(N) 1.5, 3 LTKD-H (N) 6, 12, 20 LTKD (N) 30, 50, 100 LTKD OI 200 LTKD PI 30, 50, LTKD (N) 6, 12, 20, 30, 50, 100 STDK OI 80, 200 STDK PI 20, 30, 50, 100 STDK (N) 10, 20, 50 DPSK (N) 10, 20, 50 DPSKII																																								
Phillips	 <p>Unit : mm</p> <table border="1"> <thead> <tr> <th>φD</th> <th>Bit sizes</th> </tr> </thead> <tbody> <tr> <td rowspan="4">3.5φ</td> <td>No.00</td> </tr> <tr> <td>No.0</td> </tr> <tr> <td>No.1</td> </tr> <tr> <td>No.2</td> </tr> </tbody> </table>	φD	Bit sizes	3.5φ	No.00	No.0	No.1	No.2	 <p>Unit : mm</p> <table border="1"> <thead> <tr> <th>φD</th> <th>Bit sizes</th> </tr> </thead> <tbody> <tr> <td rowspan="4">3.5φ</td> <td>No.00</td> </tr> <tr> <td>No.0</td> </tr> <tr> <td>No.1</td> </tr> <tr> <td>No.2</td> </tr> </tbody> </table>	φD	Bit sizes	3.5φ	No.00	No.0	No.1	No.2	 <p>Unit : mm</p> <table border="1"> <thead> <tr> <th>φD</th> <th>Bit sizes</th> </tr> </thead> <tbody> <tr> <td rowspan="2">4φ</td> <td>No.0</td> </tr> <tr> <td>No.1</td> </tr> <tr> <td rowspan="2">7φ</td> <td>No.2</td> </tr> <tr> <td>No.3</td> </tr> </tbody> </table>	φD	Bit sizes	4φ	No.0	No.1	7φ	No.2	No.3																		
φD	Bit sizes																																										
3.5φ	No.00																																										
	No.0																																										
	No.1																																										
	No.2																																										
φD	Bit sizes																																										
3.5φ	No.00																																										
	No.0																																										
	No.1																																										
	No.2																																										
φD	Bit sizes																																										
4φ	No.0																																										
	No.1																																										
7φ	No.2																																										
	No.3																																										
Slot Drive	 <p>Unit : mm</p> <table border="1"> <thead> <tr> <th>Blade thickness</th> <th>Width</th> </tr> </thead> <tbody> <tr> <td>0.4mm</td> <td>3.5mm</td> </tr> </tbody> </table>	Blade thickness	Width	0.4mm	3.5mm	 <p>Unit : mm</p> <table border="1"> <thead> <tr> <th>Blade thickness</th> <th>Width</th> </tr> </thead> <tbody> <tr> <td>0.4mm</td> <td>3.5mm</td> </tr> </tbody> </table>	Blade thickness	Width	0.4mm	3.5mm	 <p>Unit : mm</p> <table border="1"> <thead> <tr> <th>Blade thickness</th> <th>Width</th> </tr> </thead> <tbody> <tr> <td>0.4mm</td> <td>4.0mm</td> </tr> <tr> <td>1.0mm</td> <td>7.0mm</td> </tr> </tbody> </table>	Blade thickness	Width	0.4mm	4.0mm	1.0mm	7.0mm																										
Blade thickness	Width																																										
0.4mm	3.5mm																																										
Blade thickness	Width																																										
0.4mm	3.5mm																																										
Blade thickness	Width																																										
0.4mm	4.0mm																																										
1.0mm	7.0mm																																										
BOX BITS (Female Hex)	 <p>Unit : mm</p> <table border="1"> <thead> <tr> <th colspan="5">Width across flats</th> </tr> </thead> <tbody> <tr> <td>3</td> <td>4</td> <td>5</td> <td>5.5</td> <td>6</td> </tr> </tbody> </table>	Width across flats					3	4	5	5.5	6	 <p>Unit : mm</p> <table border="1"> <thead> <tr> <th colspan="5">Width across flats</th> </tr> </thead> <tbody> <tr> <td>3</td> <td>4</td> <td>5</td> <td>5.5</td> <td>6</td> </tr> </tbody> </table>	Width across flats					3	4	5	5.5	6	 <p>Unit : mm</p> <table border="1"> <thead> <tr> <th colspan="5">Width across flats</th> </tr> </thead> <tbody> <tr> <td>4</td> <td>5</td> <td>5.5</td> <td>6</td> <td>7</td> </tr> <tr> <td>8</td> <td>9</td> <td>10</td> <td>11</td> <td>12</td> </tr> <tr> <td>13</td> <td>14</td> <td>17</td> <td></td> <td></td> </tr> </tbody> </table>	Width across flats					4	5	5.5	6	7	8	9	10	11	12	13	14	17		
Width across flats																																											
3	4	5	5.5	6																																							
Width across flats																																											
3	4	5	5.5	6																																							
Width across flats																																											
4	5	5.5	6	7																																							
8	9	10	11	12																																							
13	14	17																																									
HEX BITS (Male Hex)	 <p>Unit : mm</p> <table border="1"> <thead> <tr> <th colspan="5">Edge size (H) mm</th> </tr> </thead> <tbody> <tr> <td>1.27</td> <td>1.5</td> <td>2</td> <td>2.5</td> <td>3</td> </tr> </tbody> </table>	Edge size (H) mm					1.27	1.5	2	2.5	3	 <p>Unit : mm</p> <table border="1"> <thead> <tr> <th colspan="5">Edge size (H) mm</th> </tr> </thead> <tbody> <tr> <td>1.27</td> <td>1.5</td> <td>2</td> <td>2.5</td> <td>3</td> </tr> </tbody> </table>	Edge size (H) mm					1.27	1.5	2	2.5	3	 <p>Unit : mm</p> <table border="1"> <thead> <tr> <th colspan="5">Edge size (H) mm</th> </tr> </thead> <tbody> <tr> <td>1.27</td> <td>1.5</td> <td>2</td> <td>2.5</td> <td>3</td> </tr> <tr> <td>4</td> <td>5</td> <td>6</td> <td>8</td> <td></td> </tr> </tbody> </table>	Edge size (H) mm					1.27	1.5	2	2.5	3	4	5	6	8						
Edge size (H) mm																																											
1.27	1.5	2	2.5	3																																							
Edge size (H) mm																																											
1.27	1.5	2	2.5	3																																							
Edge size (H) mm																																											
1.27	1.5	2	2.5	3																																							
4	5	6	8																																								

What is torque ?

The torque is a unit to tighten a screw.

It means rotating force, and should be clearly distinguished from tensible force.

The torque wrench (torque driver) belongs to the field of rotating torque. It may be said that the simple lever is applied to the torque. For the both members are closely related to <force> and <distance>. A distance is a length of a bar, force is referred to a sum of force weighing on the bar's end.

For example, the bar length is 20cm, where 5kgf (a force unit indicated kgf) is added, — a formula is established as follows. However, provided that there are presented factors such as:

T=torque (kgf·cm, kgf·m)
F=added force (kgf), F means force.
L=bar length (cm,m),

the torque can be obtained as follows;

F(force)×L(length)=T(torque),
accordingly, 5kgf×20cm=100kgf·cm

In order to obtain 100kgf·cm torque, length and force are estimated as follows.

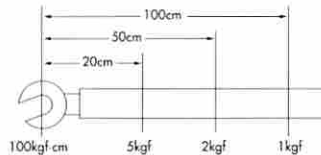

TORQUE
100kg·cm=5kgf×20cm
=2kgf×50cm
=1kgf×100cm

PARTS FOR QLK, QSPK AND QCK

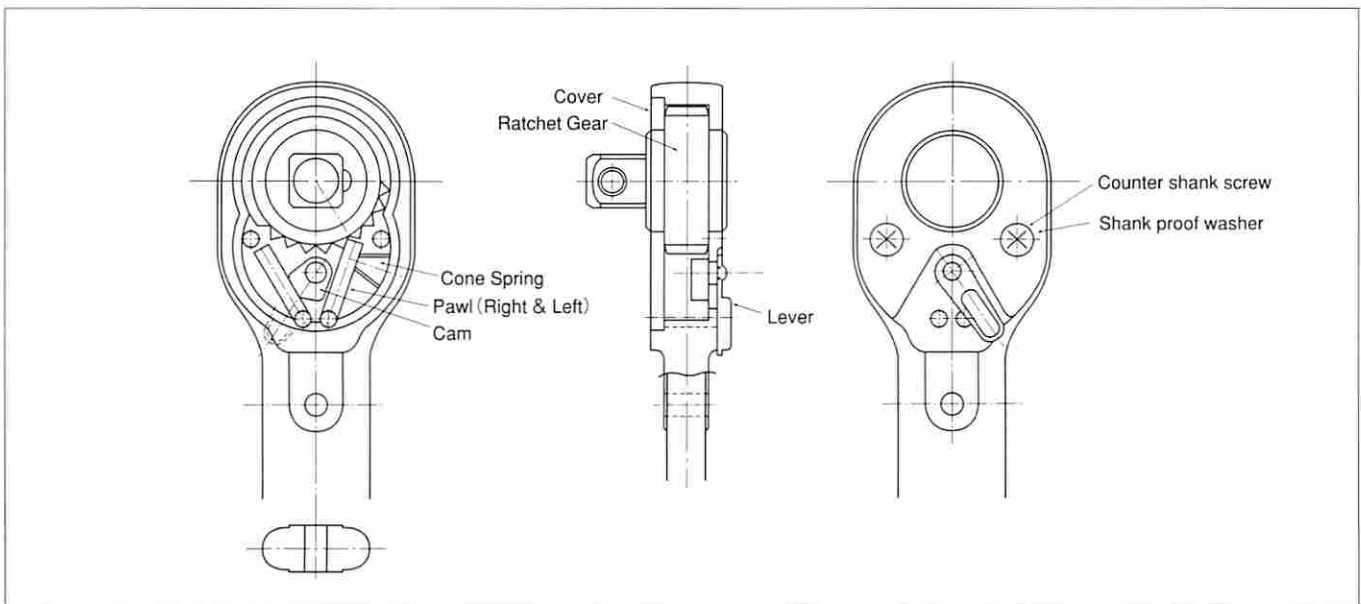

Torque unit and conversion table

	Drive unit (kilo-gram-cm)	SI unit (Newton meter)	Inch and pound unit
Torque unit	kgf·cm kgf·m gf·cm	N·m cN·m	lbf·in lbf·ft OZf·in
Conversion in unit	1 kgf·m=100 kgf·cm 1 kgf·cm=1000 gf·cm 1 kgf·cm=10 kgf·mm	1 N·m=100 cN·m	1 lbf·ft=12 lbf·in 1 lbf·in=16 OZf·in
Conversion between units	1 kgf·cm=0.098065 N·m 1 kgf·cm=0.867962 lbf·in 1 kgf·cm=0.072330 lbf·ft	1 N·m=10.1972 kgf·cm 1 N·m=8.85 lbf·in 1 N·m=0.737562 lbf·ft	1 lbf·in=1.15 kgf·cm 1 lbf·in=0.112985 N·m 1 lbf·ft=1.365 kgf·cm 1 lbf·ft=1.36 N·m
Force unit	1 kgf·cm=9.807 N 1 kgf·cm=2.205 lbf	1 N=0.101972 kgf 1 N=0.224809 lbf	1 lbf=0.453592 kgf 1 lbf=4.448 N (1 lbf=16 OZf)
Length unit	1 cm=0.393701 in	1 m=3.281 ft	1 in=2.54 cm 1 ft=0.305 m (1 ft=12 in)